

Electrobombas centrífugas normalizadas "EN 733"

 Agua limpia

 Utilizo industrial

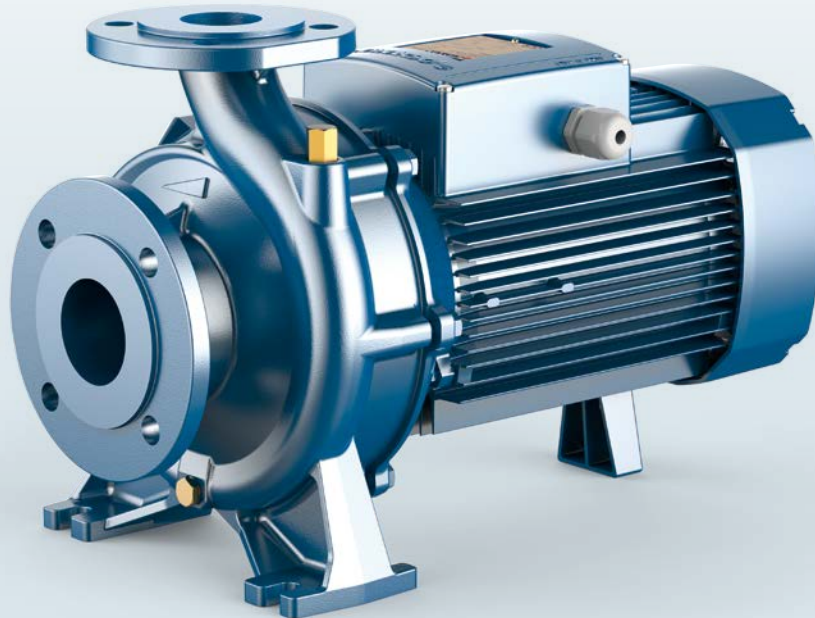

CAMPO DE PRESTACIONES

- Caudal hasta **5500 l/min** (330 m³/h)
- Altura manométrica hasta **98 m**

LIMITES DE UTILIZO

- Altura de aspiración manométrica hasta **7 m**
- Temperatura del líquido de **-10 °C** hasta **+90 °C**
- Temperatura ambiente de **-10 °C** hasta **+55 °C**
- Presión máxima en el cuerpo bomba **10 bar** (PN10)
- Funcionamiento continuo **S1**

EJECUCION Y NORMAS DE SEGURIDAD

EN 60335-1
IEC 60335-1
CEI 61-150

EN 60034-1
IEC 60034-1
CEI 2-3



Dimensiones del cuerpo de la bomba conformes a la norma **EN 733**

CERTIFICACIONES

Empresa con sistema de gestión certificado DNV
ISO 9001: CALIDAD

UTILIZOS E INSTALACIONES

- Abastecimiento hídrico
- Presurización
- Irrigación
- Circulación del agua en instalaciones de climatización
- Instalaciones de lavado
- Instalaciones Anti Incendio
- Industria
- Agricultura

La instalación se debe realizar en lugares cerrados o protegidos de la intemperie.

EJECUCION BAJO PEDIDO

- KIT contrabridas completo de tornillos, tuercas y juntas
- Sello mecánico especial
- Otros voltajes
- Para líquidos con temperaturas más altas o más bajas
- Para ambientes con temperaturas más altas o más bajas

GARANTIA

2 años según nuestras condiciones generales de venta

CAMPO DE PRESTACIONES

60 Hz n= 3450 min⁻¹

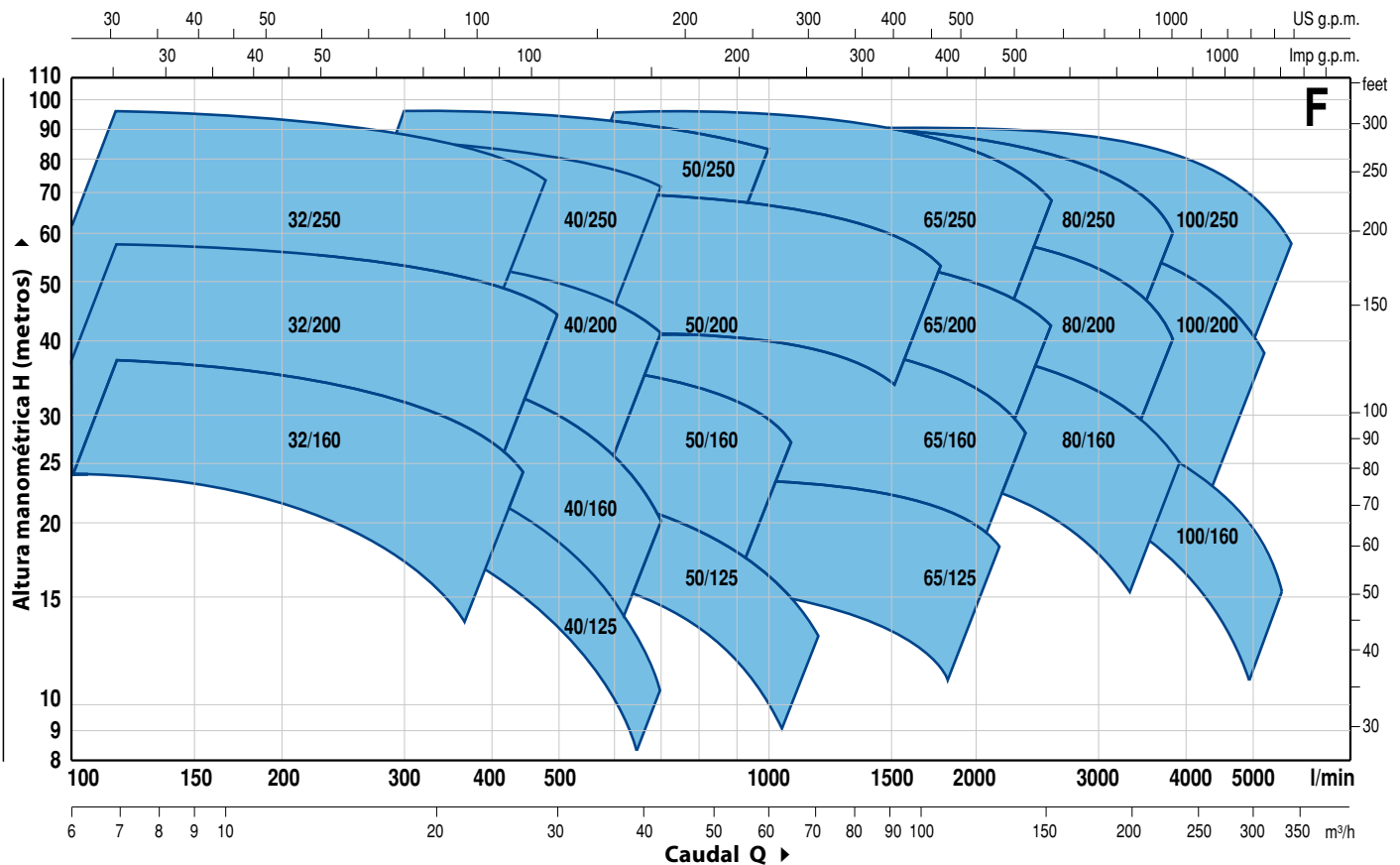

DATOS DE PRESTACIONES

60 Hz n= 3450 min⁻¹

MODELO	POTENCIA (P ₂)		▲	PRESTACIONES	
	kW	HP		Q l/min	H metros
F 32/160C	1.5	2	IE3	100 ÷ 350	24 ÷ 14
F 32/160B	2.2	3		100 ÷ 400	30 ÷ 17
F 32/160A	3	4		100 ÷ 450	37 ÷ 24
F 32/200C	4	5.5	IE3	100 ÷ 450	44 ÷ 31.5
F 32/200B	5.5	7.5		100 ÷ 500	51 ÷ 36
F 32/200A	7.5	10		100 ÷ 500	57 ÷ 44
F 32/200BH	3	4	IE3	100 ÷ 300	45 ÷ 37
F 32/200AH	4	5.5		100 ÷ 320	55 ÷ 44
F 32/250C	9.2	12.5		100 ÷ 450	75 ÷ 60
F 32/250B	11	15	IE3	100 ÷ 500	87 ÷ 70
F 32/250A	15	20		100 ÷ 500	97 ÷ 80
F 40/125C	1.1	1.5		100 ÷ 550	16 ÷ 6
F 40/125B	1.5	2	IE3	100 ÷ 600	20.5 ÷ 9
F 40/125A	2.2	3		100 ÷ 700	26 ÷ 10
F 40/160C	2.2	3		100 ÷ 600	27 ÷ 14
F 40/160B	3	4	IE3	100 ÷ 600	32 ÷ 20
F 40/160A	4	5.5		100 ÷ 700	38 ÷ 20
F 40/200B	5.5	7.5		100 ÷ 700	47 ÷ 28
F 40/200A	7.5	10	IE3	100 ÷ 700	55 ÷ 41
F 40/250C	9.2	12.5		100 ÷ 700	64 ÷ 47
F 40/250B	11	15		100 ÷ 700	71 ÷ 55
F 40/250A	15	20	IE3	100 ÷ 700	88 ÷ 72
F 50/125C	2.2	3		300 ÷ 1200	17.5 ÷ 6
F 50/125B	3	4		IE3	300 ÷ 1200
F 50/125A	4	5.5	300 ÷ 1200		23.5 ÷ 13
F 50/160C	4	5.5	300 ÷ 1000		27 ÷ 16
F 50/160B	5.5	7.5	IE3	300 ÷ 1100	32 ÷ 21
F 50/160A	7.5	10		300 ÷ 1100	37 ÷ 27
F 50/200C	11	15		400 ÷ 1700	44 ÷ 30
F 50/200B	15	20	IE3	400 ÷ 1700	52 ÷ 38
F 50/200A	18.5	25		400 ÷ 1800	61 ÷ 45
F 50/200AR	22	30		400 ÷ 1800	69 ÷ 53
F 50/250D	9.2	12.5	IE3	300 ÷ 900	51 ÷ 32
F 50/250C	11	15		300 ÷ 900	59 ÷ 42
F 50/250B	15	20		300 ÷ 1000	72 ÷ 59
F 50/250A	18.5	25	IE3	300 ÷ 1000	85 ÷ 73
F 50/250AR	22	30		300 ÷ 1000	95 ÷ 83

MODELO	POTENCIA (P ₂)		▲	PRESTACIONES	
	kW	HP		Q l/min	H metros
F 65/125C	4	5.5	IE3	600 ÷ 1800	16 ÷ 11
F 65/125B	5.5	7.5		600 ÷ 2000	18 ÷ 13
F 65/125A	7.5	10		600 ÷ 2200	23 ÷ 18
F 65/160C	9.2	12.5	IE3	600 ÷ 2200	32 ÷ 22
F 65/160B	11	15		600 ÷ 2400	36.5 ÷ 23
F 65/160A	15	20		600 ÷ 2400	40.5 ÷ 28
F 65/200B	15	20	IE3	200 ÷ 2400	44 ÷ 30.5
F 65/200A	18.5	25		200 ÷ 2500	50 ÷ 36.5
F 65/200AR	22	30		200 ÷ 2600	57 ÷ 42
F 65/250C	30	40	IE3	400 ÷ 2350	76 ÷ 53
F 65/250B	37	50		400 ÷ 2500	87 ÷ 62
F 65/250A	45	60		400 ÷ 2600	95 ÷ 68
F 65/160D	11	15	IE3	500 ÷ 4000	25 ÷ 10
F 80/160C	15	20		500 ÷ 4000	30 ÷ 15
F 80/160B	18.5	25		500 ÷ 4000	35 ÷ 20
F 80/160A	22	30	IE3	500 ÷ 4000	40 ÷ 25
F 80/200B	30	40		500 ÷ 3650	56 ÷ 34.5
F 80/200A	37	50		500 ÷ 3900	62 ÷ 40
F 80/250B	45	60	IE3	600 ÷ 3600	77 ÷ 54
F 80/250A	55	75		600 ÷ 3900	88.5 ÷ 60
F 100/160A-N	22	30		1000 ÷ 5500	40 ÷ 16.5
F 100/200C	30	40	IE3	833 ÷ 4650	51 ÷ 28
F 100/200B	37	50		833 ÷ 4900	57 ÷ 33
F 100/200A	45	60		833 ÷ 5250	63 ÷ 38
F 100/250B	55	75	IE3	800 ÷ 5150	75 ÷ 48
F 100/250A	75	100		800 ÷ 5750	89 ÷ 58

Q = Caudal

H = Altura manométrica total

Tolerancia de las curvas de prestación según EN ISO9906 Grado 3B.

▲ Clase de rendimiento del motor trifásico (IEC 60034-30)

F32/160

CURVAS Y DATOS DE PRESTACIONES

60 Hz n = 3450 min⁻¹ HS = 0 m

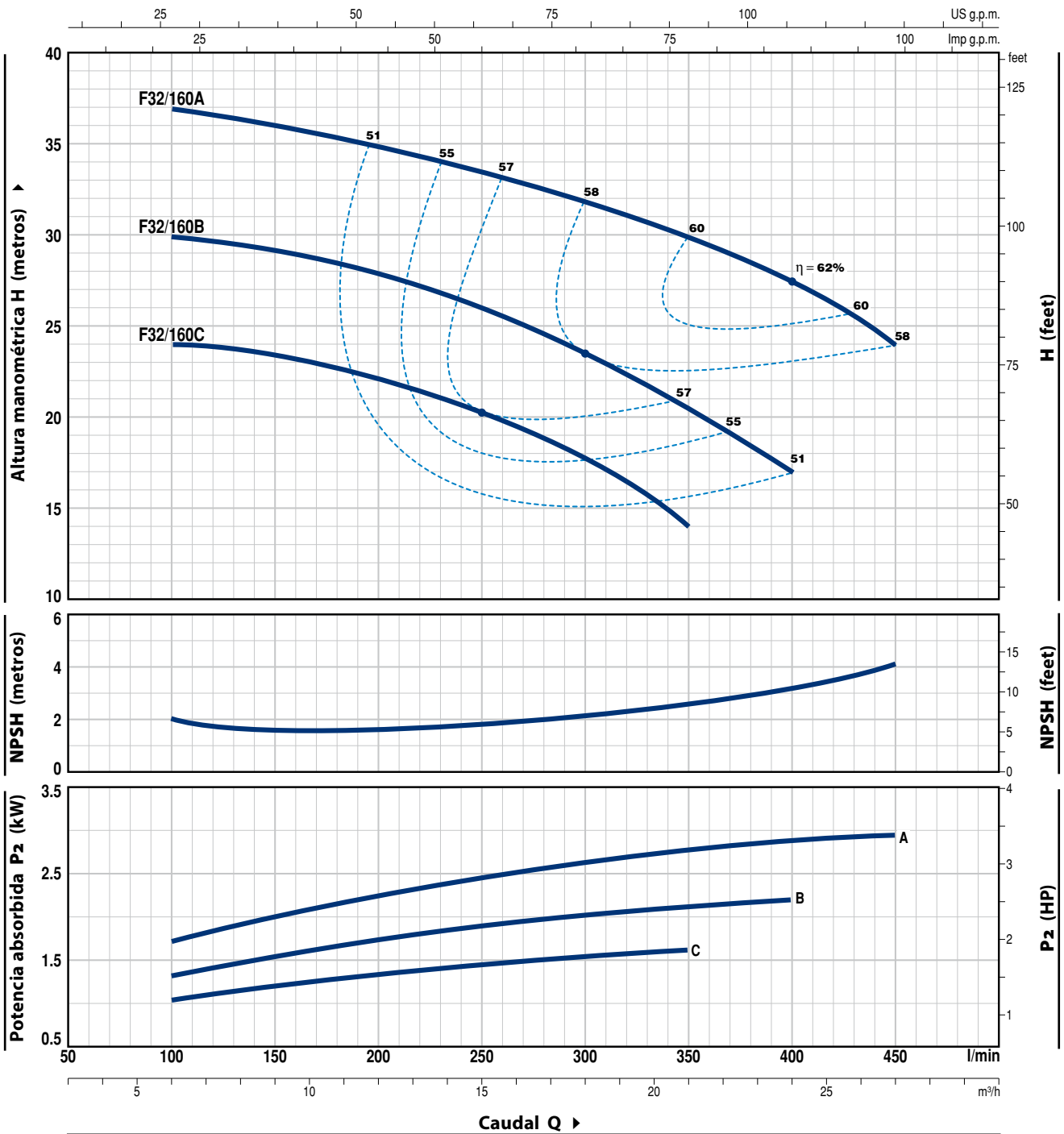

MODELO		POTENCIA (P ₂)		Q	Caudal												
Monofásica	Trifásica	kW	HP		m ³ /h	0	6	9	12	15	18	21	24	27			
Fm 32/160C	F 32/160C	1.5	2	l/min	0	100	150	200	250	300	350	400	450				
				H metros	25	24	23.5	22	20.5	18	14						
					31	30	29	28	26	23.5	20.5	17					
					38	37	36	35	33.5	31.5	30	27.5	24				

Q = Caudal H = Altura manométrica total HS = Altura de aspiración

Tolerancia de las curvas de prestación según EN ISO9906 Grado 3B.

CURVAS Y DATOS DE PRESTACIONES

60 Hz n = 3450 min⁻¹ HS = 0 m

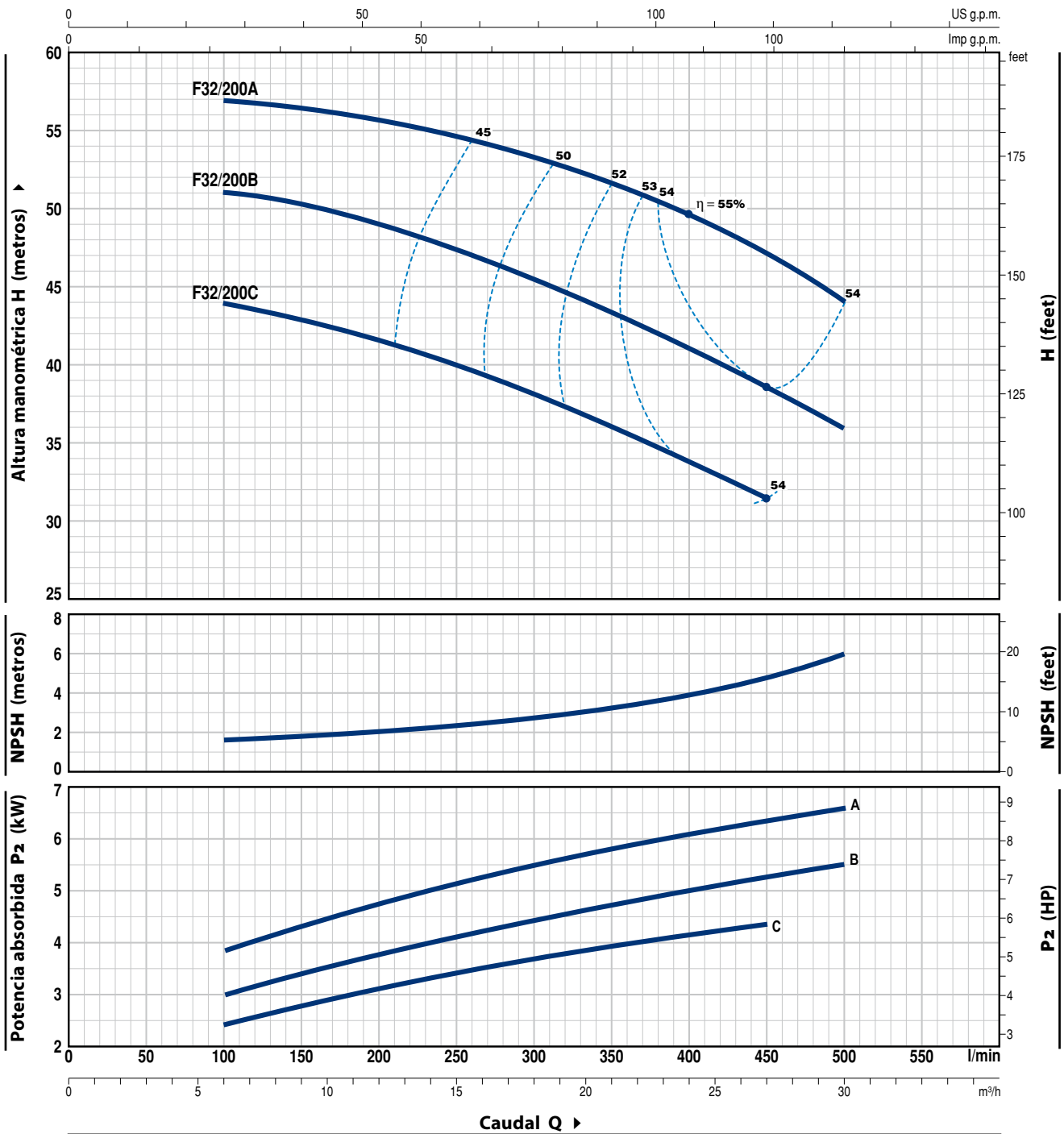

MODELO	POTENCIA (P ₂)		Q	Caudal												
	kW	HP		0	6	9	12	15	18	21	24	27	30			
Trifásica			Q	0	100	150	200	250	300	350	400	450	500			
F 32/200C	4	5.5	H metros	46	44	43	41.5	40	38	36	34	31.5				
F 32/200B	5.5	7.5		52	51	50.5	49	47	45	43	41	38.5	36			
F 32/200A	7.5	10		60	57	56.5	56	55	53.5	52	50	47	44			

Q = Caudal H = Altura manométrica total HS = Altura de aspiración

Tolerancia de las curvas de prestación según EN ISO9906 Grado 3B.

F32/200H

CURVAS Y DATOS DE PRESTACIONES

60 Hz n = 3450 min⁻¹ HS = 0 m

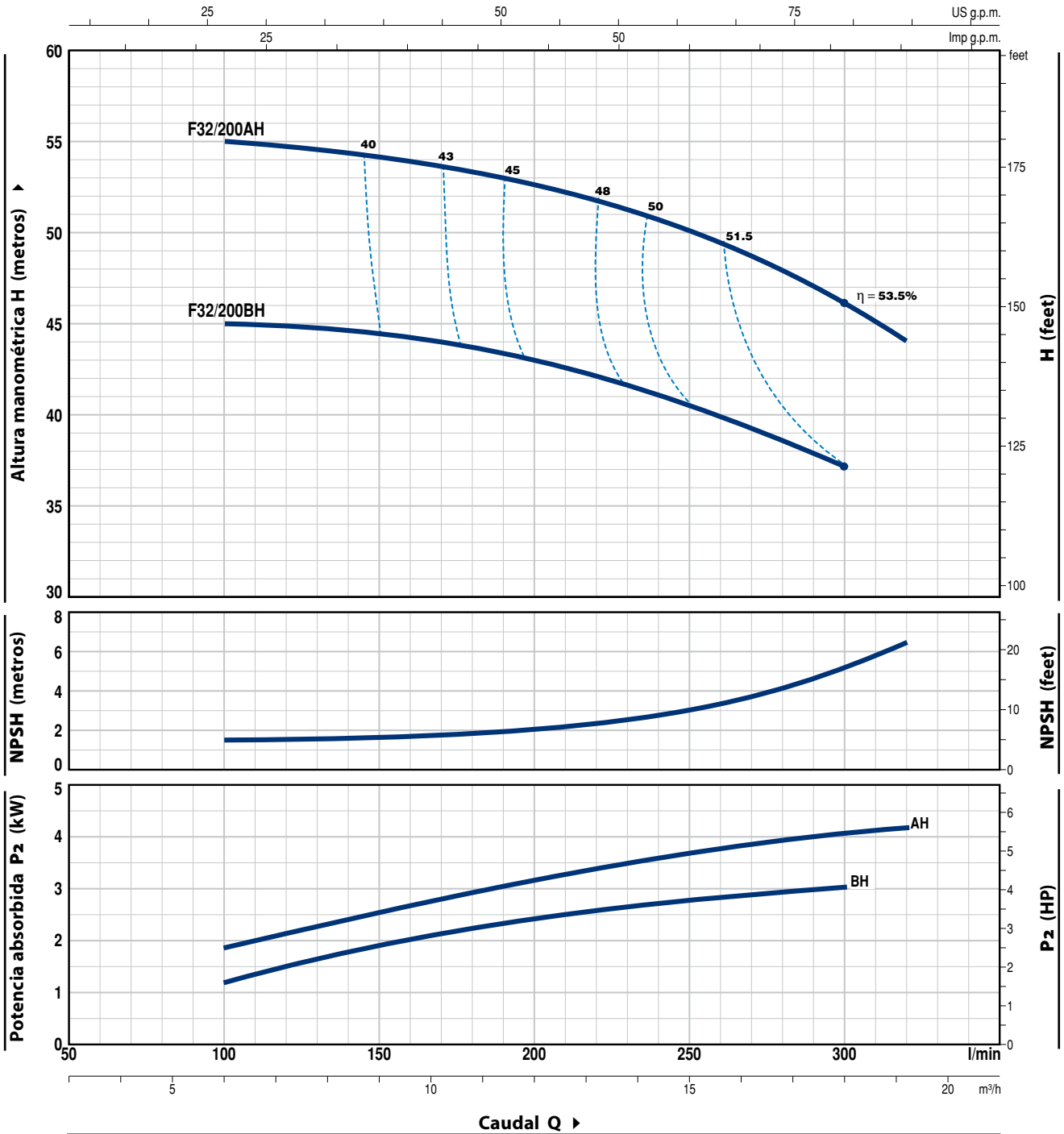

MODELO	POTENCIA (P ₂)		Q	H (metros)						
	kW	HP		0	6	9	12	15	18	19.2
Trifásica			l/min	0	100	150	200	250	300	320
F 32/200BH	3	4	H metros	47	45	44.5	43	40.5	37	
F 32/200AH	4	5.5		57	55	54	52.5	50	46	44

Q = Caudal H = Altura manométrica total HS = Altura de aspiración

Tolerancia de las curvas de prestación según EN ISO9906 Grado 3B.

CURVAS Y DATOS DE PRESTACIONES

60 Hz n = 3450 min⁻¹ HS = 0 m

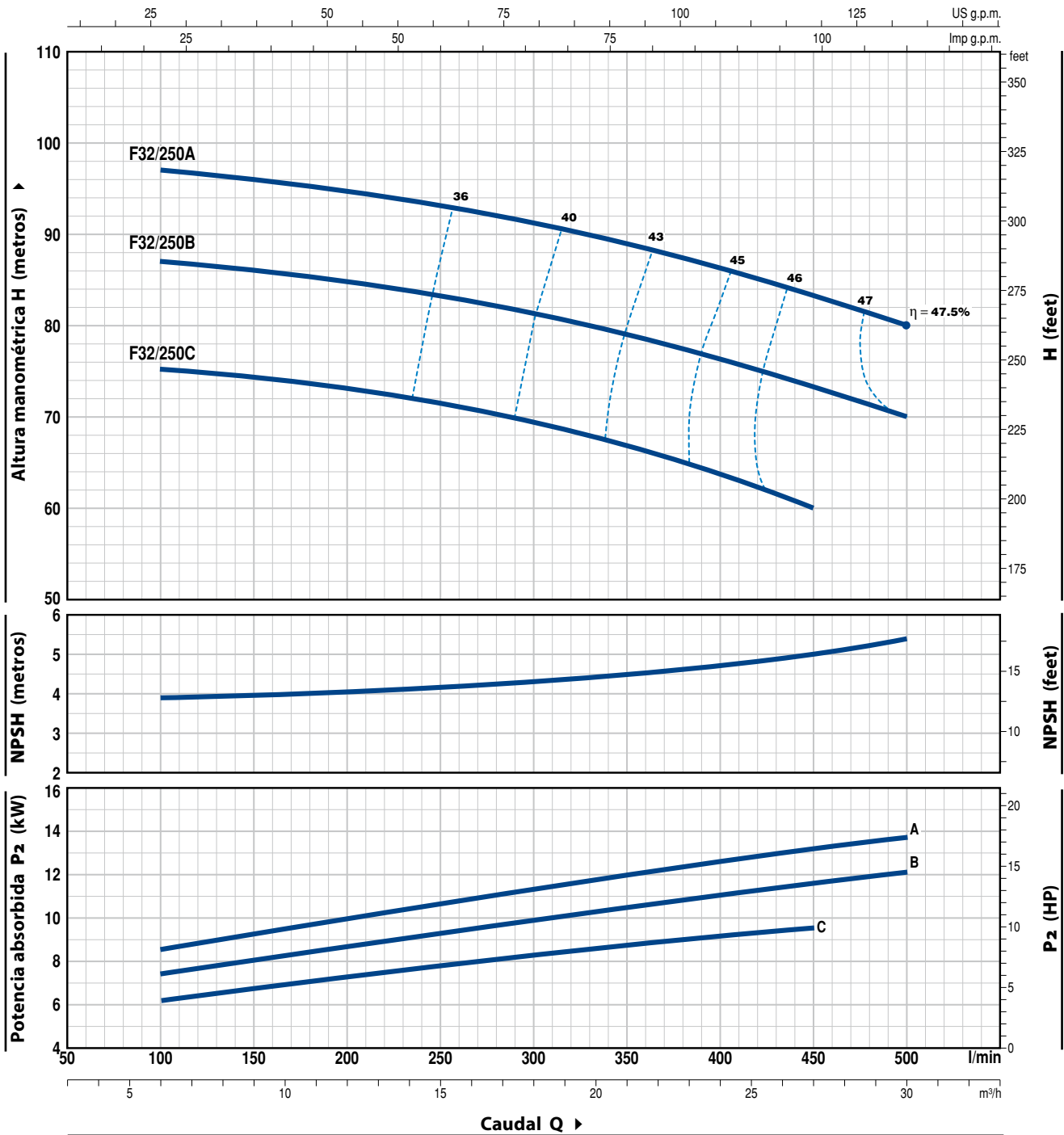

MODELO	POTENCIA (P ₂)		Q	Flow Rate (Q)											
	kW	HP		0	6	9	12	15	18	21	24	27	30		
Trifásica			l/min	0	100	150	200	250	300	350	400	450	500		
F 32/250C	9.2	12.5	H metros	76	75	74.5	73	71.5	69.5	67	64	60			
F 32/250B	11	15		88	87	86	85	83	81	79	76.5	73.5	70		
F 32/250A	15	20		98	97	96	95	93	91	89	86.5	83.5	80		

Q = Caudal H = Altura manométrica total HS = Altura de aspiración

Tolerancia de las curvas de prestación según EN ISO9906 Grado 3B.

F40/125

CURVAS Y DATOS DE PRESTACIONES

60 Hz n = 3450 min⁻¹ HS = 0 m

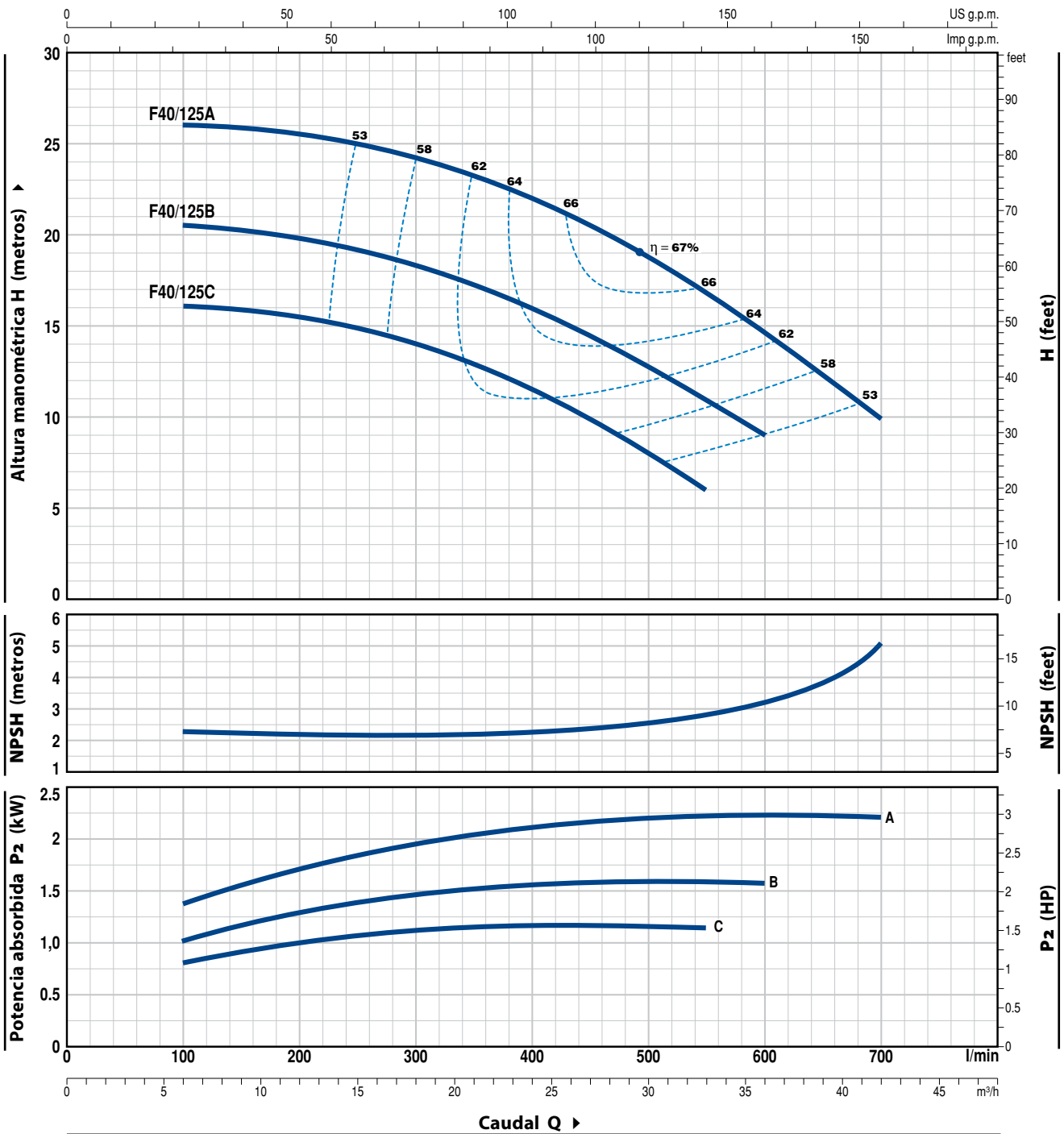

MODELO		POTENCIA (P ₂)		Q	Flow Rate												
Monofásica	Trifásica	kW	HP		m³/h	0	6	12	18	24	30	33	36	39	42		
Fm 40/125C	F 40/125C	1.1	1.5	l/min	0	100	200	300	400	500	550	600	650	700			
				H metros	16	16	15.5	14	11.5	8	6						
					20.5	20.5	19.8	18.5	16	12.8	11	9					
					26	26	25.5	24	22	18.5	17	14.5	12.5	10			

Q = Caudal H = Altura manométrica total HS = Altura de aspiración

Tolerancia de las curvas de prestación según EN ISO9906 Grado 3B.

CURVAS Y DATOS DE PRESTACIONES

60 Hz n = 3450 min⁻¹ HS = 0 m

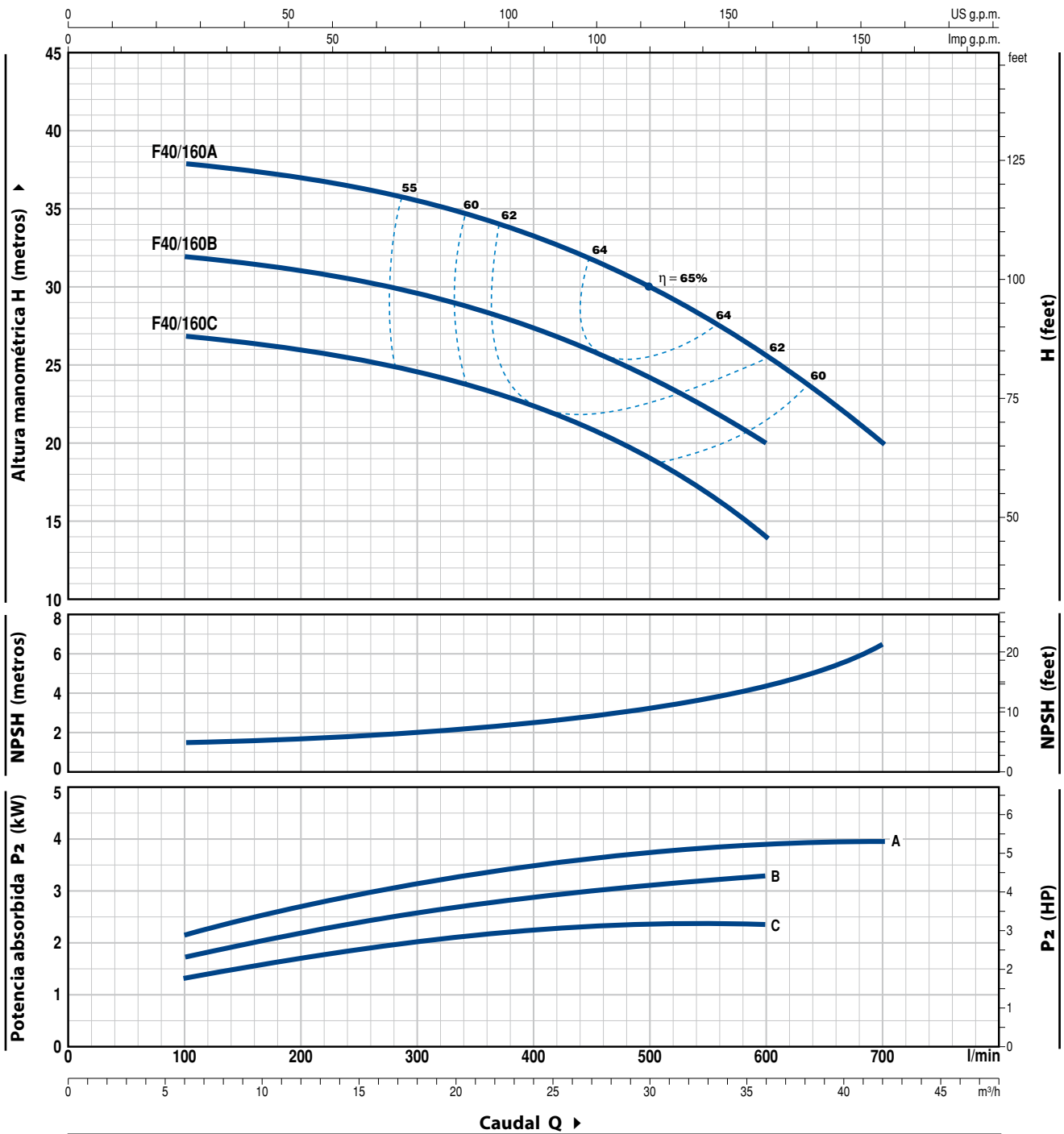

MODELO		POTENCIA (P ₂)		Q	Caudal													
Monofásica	Trifásica	kW	HP		m ³ /h	0	6	9	12	15	18	24	30	36	42			
Fm 40/160C	F 40/160C	2.2	3	l/min	0	100	150	200	250	300	400	500	600	700				
-	F 40/160B	3	4	H metros	27	27	26.5	26	25.5	25	22.5	19	14					
-	F 40/160A	4	5.5		32	32	31.5	31	30.5	30	27.5	24	20					
					38	38	37.8	37	36.5	36	33.5	30	26	20				

Q = Caudal H = Altura manométrica total HS = Altura de aspiración

Tolerancia de las curvas de prestación según EN ISO9906 Grado 3B.

F40/200

CURVAS Y DATOS DE PRESTACIONES

60 Hz n = 3450 min⁻¹ HS = 0 m

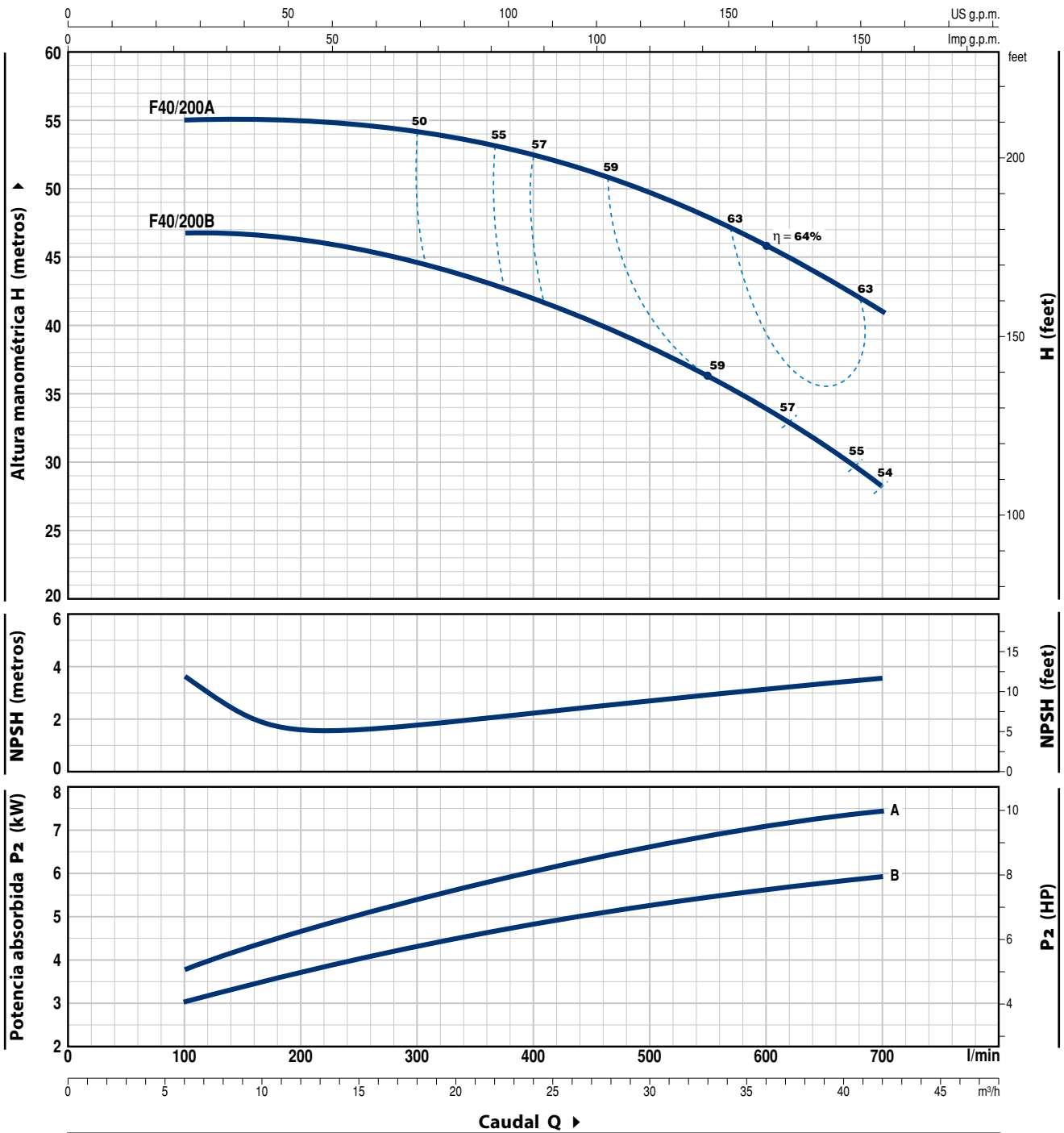

MODELO	POTENCIA (P ₂)		Q	m ³ /h											
	kW	HP		0	6	9	12	15	18	24	30	36	42		
Trifásica			l/min	0	100	150	200	250	300	400	500	600	700		
F 40/200B	5.5	7.5	H metros	48	47	46.5	46	45.5	44.5	42	38	34	28		
F 40/200A	7.5	10		56	55	55	55	54.5	54	52.5	49.5	46	41		

Q = Caudal H = Altura manométrica total HS = Altura de aspiración

Tolerancia de las curvas de prestación según EN ISO9906 Grado 3B.

CURVAS Y DATOS DE PRESTACIONES

60 Hz n = 3450 min⁻¹ HS = 0 m

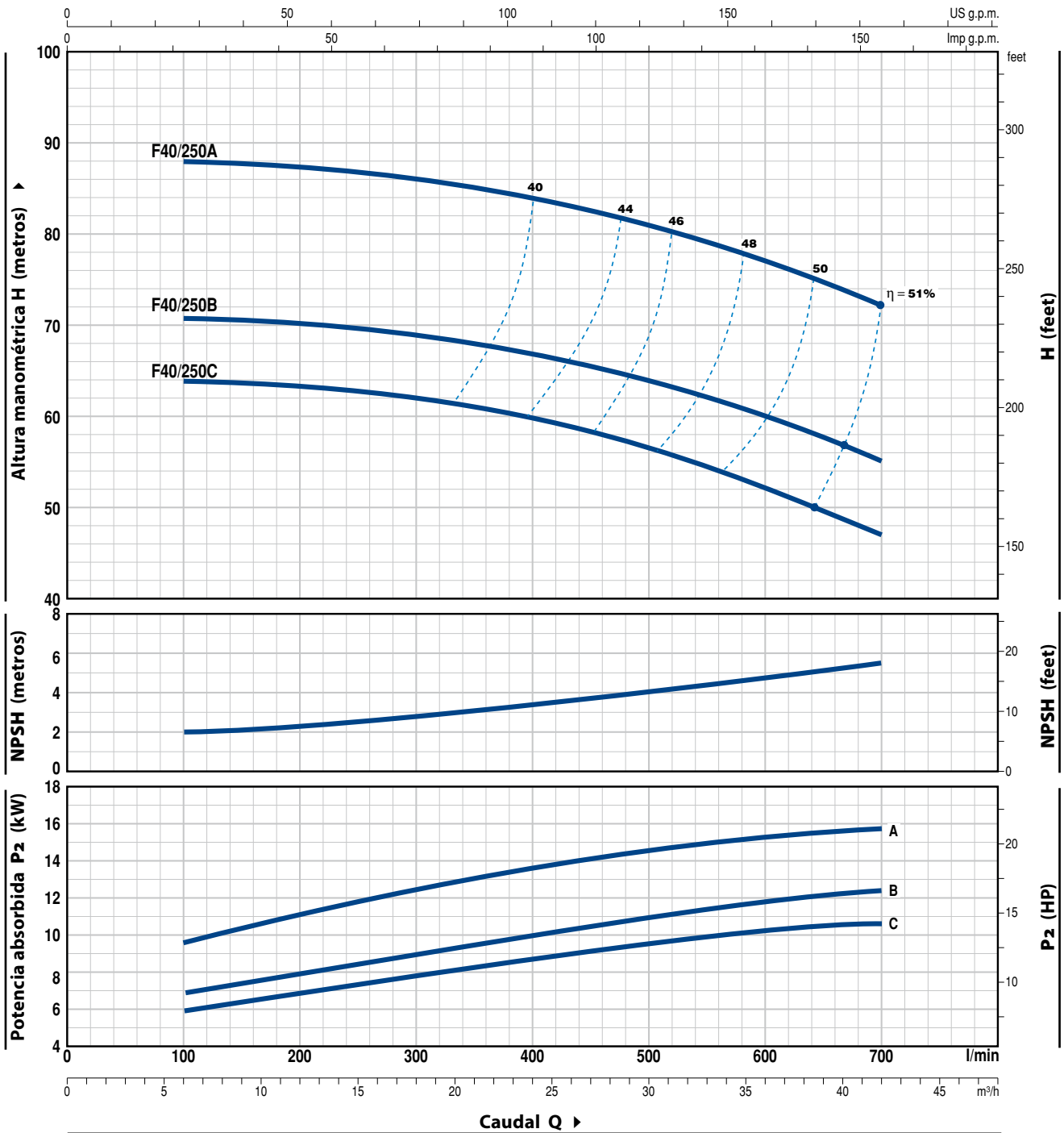

MODELO	POTENCIA (P ₂)		Q	Flow Rate (Q)											
	kW	HP		0	6	9	12	15	18	24	30	36	42		
Trifásica			l/min	0	100	150	200	250	300	400	500	600	700		
F 40/250C	9.2	12.5	H metros	64	64	63.5	63	62.5	62	60	56.5	52.5	47		
F 40/250B	11	15		71	71	70.5	70	69.5	69	67	64	60	55		
F 40/250A	15	20		88	88	87.5	87	86.5	86	84	81	77	72		

Q = Caudal H = Altura manométrica total HS = Altura de aspiración

Tolerancia de las curvas de prestación según EN ISO9906 Grado 3B.

F50/125

CURVAS Y DATOS DE PRESTACIONES

60 Hz n = 3450 min⁻¹ HS = 0 m

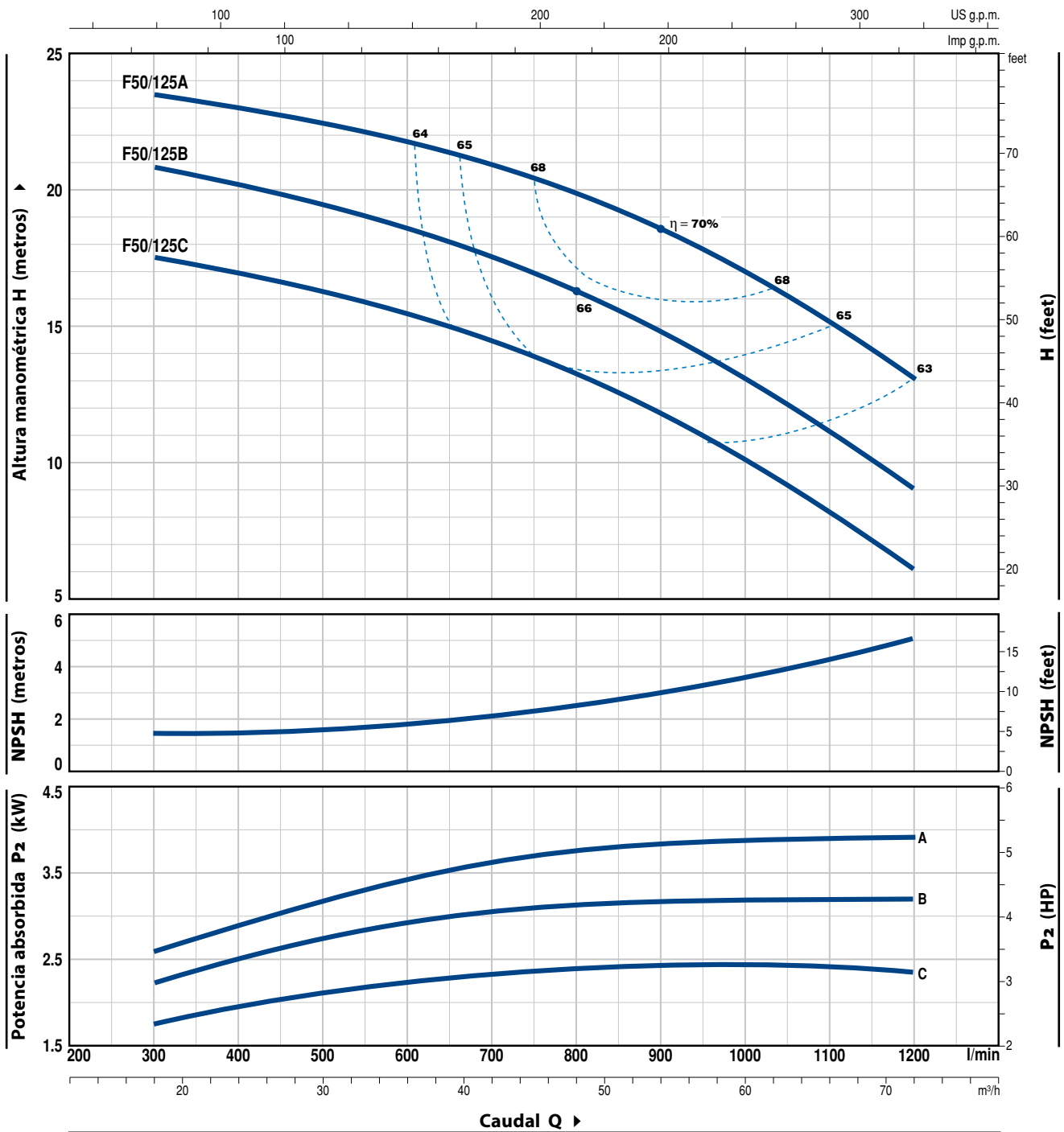

MODELO		POTENCIA (P ₂)		Q	Caudal												
Monofásica	Trifásica	kW	HP		m ³ /h	0	18	24	30	36	42	48	54	60	66	72	
Fm 50/125C	F 50/125C	2.2	3	H metros	0	300	400	500	600	700	800	900	1000	1100	1200		
-	F 50/125B	3	4		18.5	17.5	17	16.5	15.5	14.8	13.5	12	10.5	8.2	6		
-	F 50/125A	4	5.5		21.5	20.7	20	19.5	18.8	17.8	16.5	15	13.5	11.2	9		
						24.5	23.5	23	22.5	21.8	20.8	19.5	18.3	16.8	15	13	

Q = Caudal H = Altura manométrica total HS = Altura de aspiración

Tolerancia de las curvas de prestación según EN ISO9906 Grado 3B.

CURVAS Y DATOS DE PRESTACIONES

60 Hz n = 3450 min⁻¹ HS = 0 m

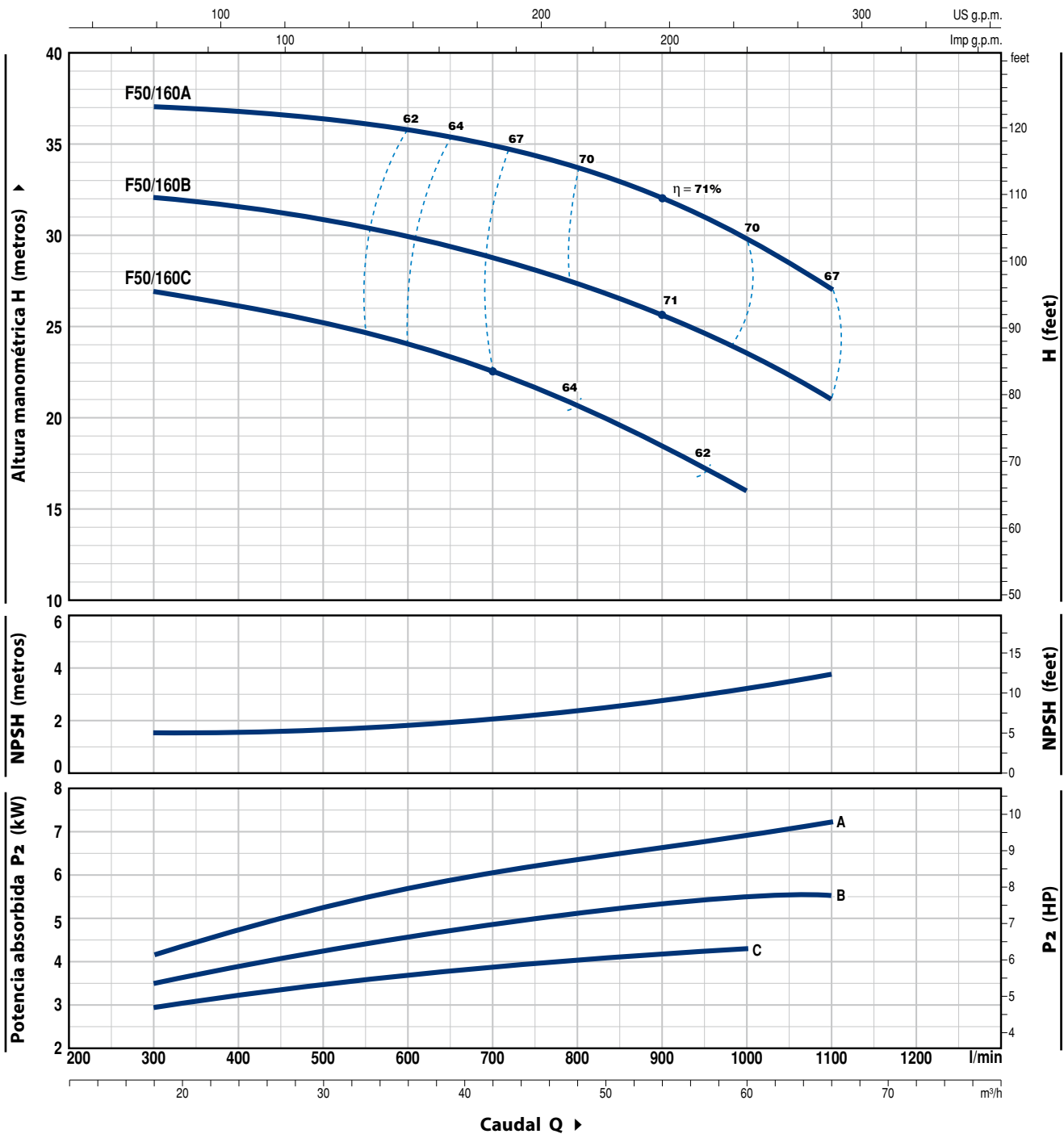

MODELO	POTENCIA (P ₂)		Q	m ³ /h											
	kW	HP		0	18	24	30	36	42	48	54	60	66		
Trifásica			l/min	0	300	400	500	600	700	800	900	1000	1100		
F 50/160C	4	5.5	H metros	27	27	26.5	25	24.5	23	20	18.5	16			
F 50/160B	5.5	7.5		33	32	31.7	31	30	29	27	26	24	21		
F 50/160A	7.5	10		38	37	36.8	36.5	36	34	33	32	30	27		

Q = Caudal H = Altura manométrica total HS = Altura de aspiración

Tolerancia de las curvas de prestación según EN ISO9906 Grado 3B.

F50/200

CURVAS Y DATOS DE PRESTACIONES

60 Hz n = 3450 min⁻¹ HS = 0 m

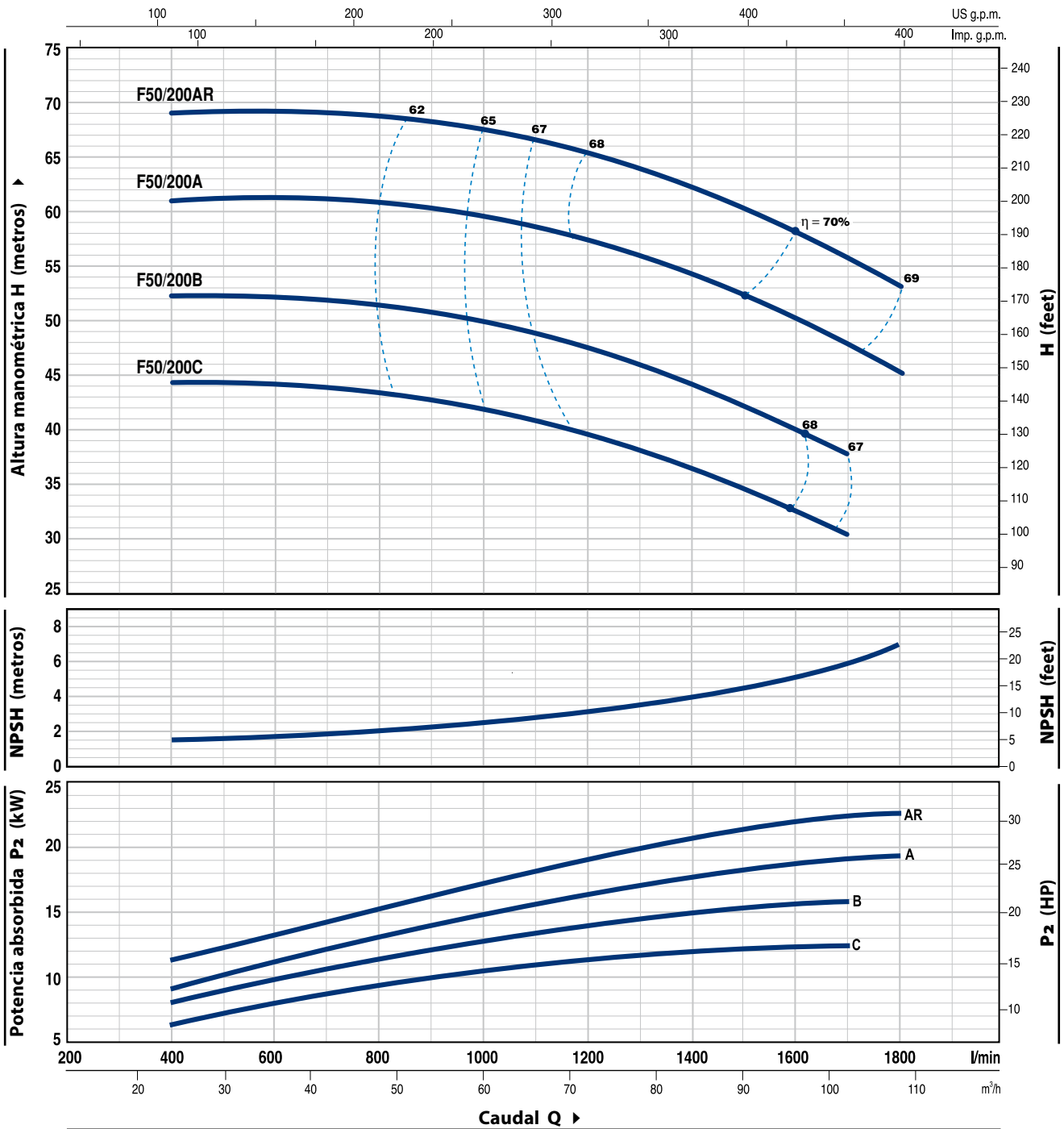

MODELO	POTENCIA (P ₂)		Q	24	36	48	60	72	84	96	102	108
	kW	HP		400	600	800	1000	1200	1400	1600	1700	1800
F 50/200C	11	15	H metros	44	44	44	42	39	36	33	30	
F 50/200B	15	20		52	52	52	50	47	44	40	38	
F 50/200A	18.5	25		61	61	60.5	60	57	54	50	48	45
F 50/200AR	22	30		69	69	68.5	68	65	62	58	56	53

Q = Caudal H = Altura manométrica total HS = Altura de aspiración

Tolerancia de las curvas de prestación según EN ISO9906 Grado 3B.

CURVAS Y DATOS DE PRESTACIONES

60 Hz n = 3450 min⁻¹ HS = 0 m

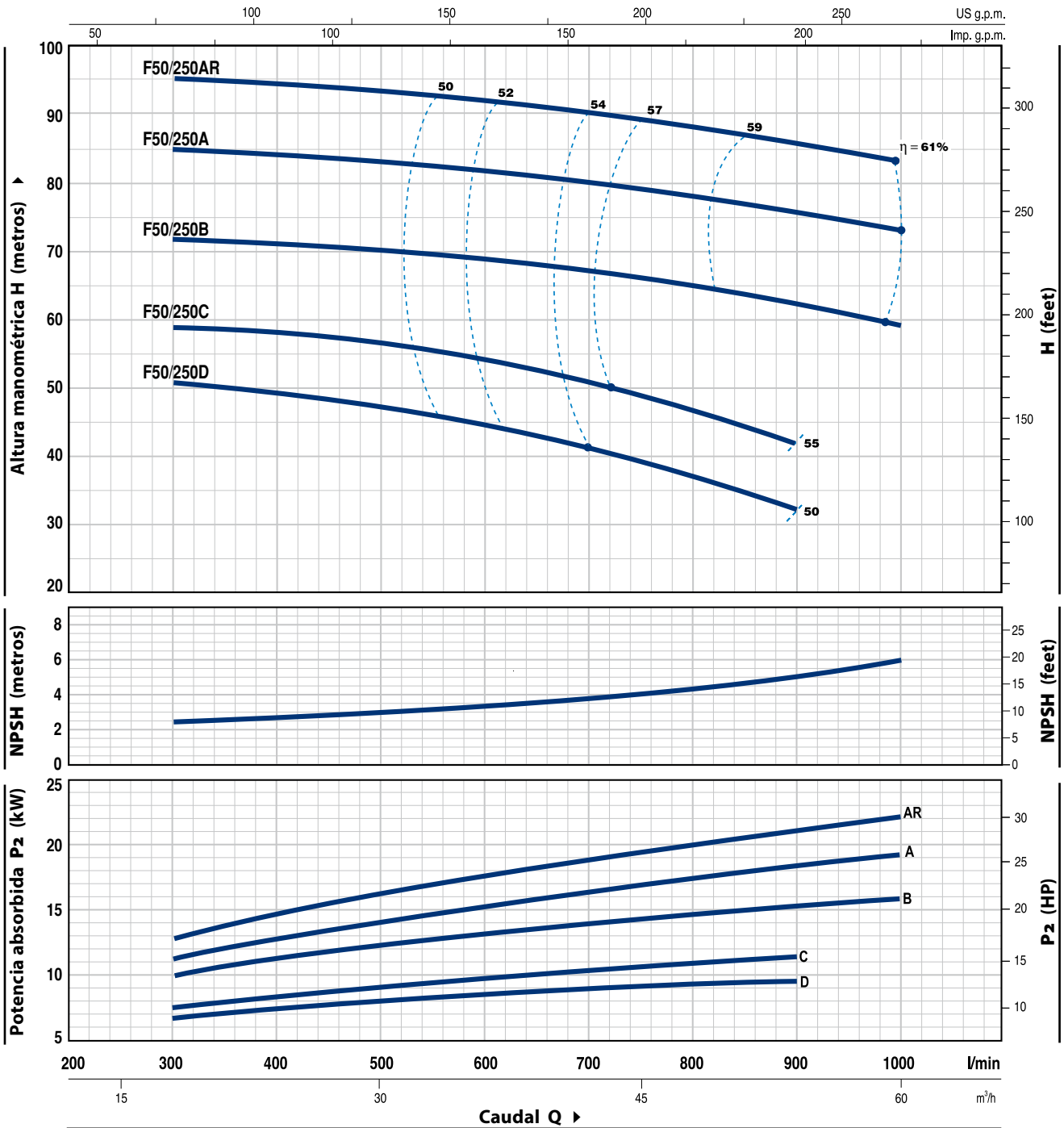

MODELO	POTENCIA (P ₂)		Q m ³ /h l/min	Caudal Q										
	kW	HP		0	18	24	30	36	42	48	54	60		
F 50/250D	9.2	12.5	H metros	51	51	49	47	44	41	37	32			
F 50/250C	11	15		59	59	58	57	54	51	47	42			
F 50/250B	15	20		72	72	71	70	69	67	65	62	59		
F 50/250A	18.5	25		85	85	84	83	82	80	78	76	73		
F 50/250AR	22	30		95	95	94	93	92	90	88	86	83		

Q = Caudal H = Altura manométrica total HS = Altura de aspiración

Tolerancia de las curvas de prestación según EN ISO9906 Grado 3B.

F65/125

CURVAS Y DATOS DE PRESTACIONES

60 Hz n = 3450 min⁻¹ HS = 0 m

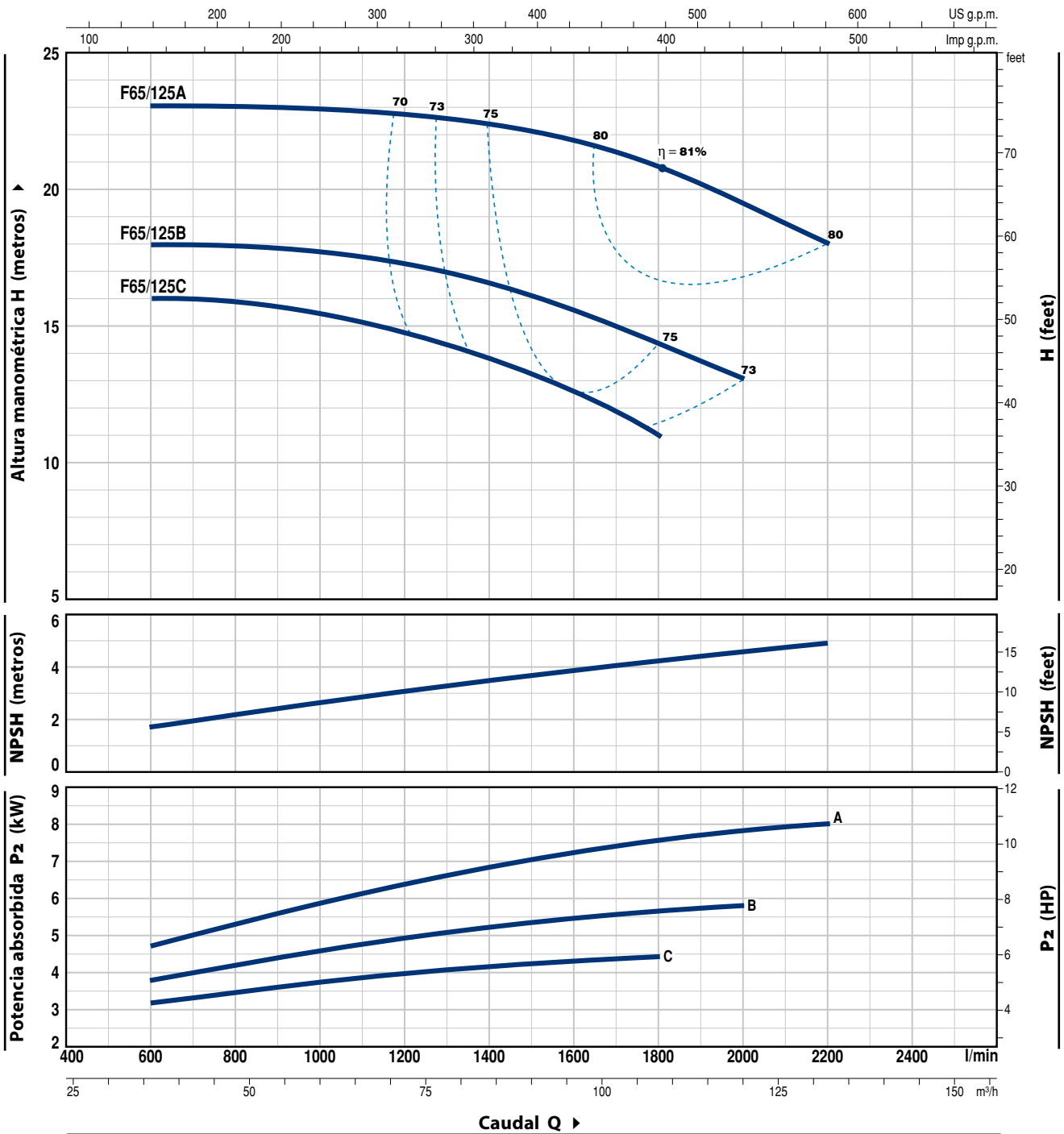

MODELO	POTENCIA (P ₂)		Q	Caudal												
	kW	HP		0	36	48	60	72	84	96	108	120	132			
Trifásica			l/min	0	600	800	1000	1200	1400	1600	1800	2000	2200			
F 65/125C	4	5.5	H metros	16	16	16	15.5	14.5	13.5	12.5	11					
F 65/125B	5.5	7.5		18	18	18	18	17	16.5	15.5	14.5	13				
F 65/125A	7.5	10		23	23	23	23	22.5	22.5	22	21	19.5	18			

Q = Caudal H = Altura manométrica total HS = Altura de aspiración

Tolerancia de las curvas de prestación según EN ISO9906 Grado 3B.

CURVAS Y DATOS DE PRESTACIONES

60 Hz n = 3450 min⁻¹ HS = 0 m

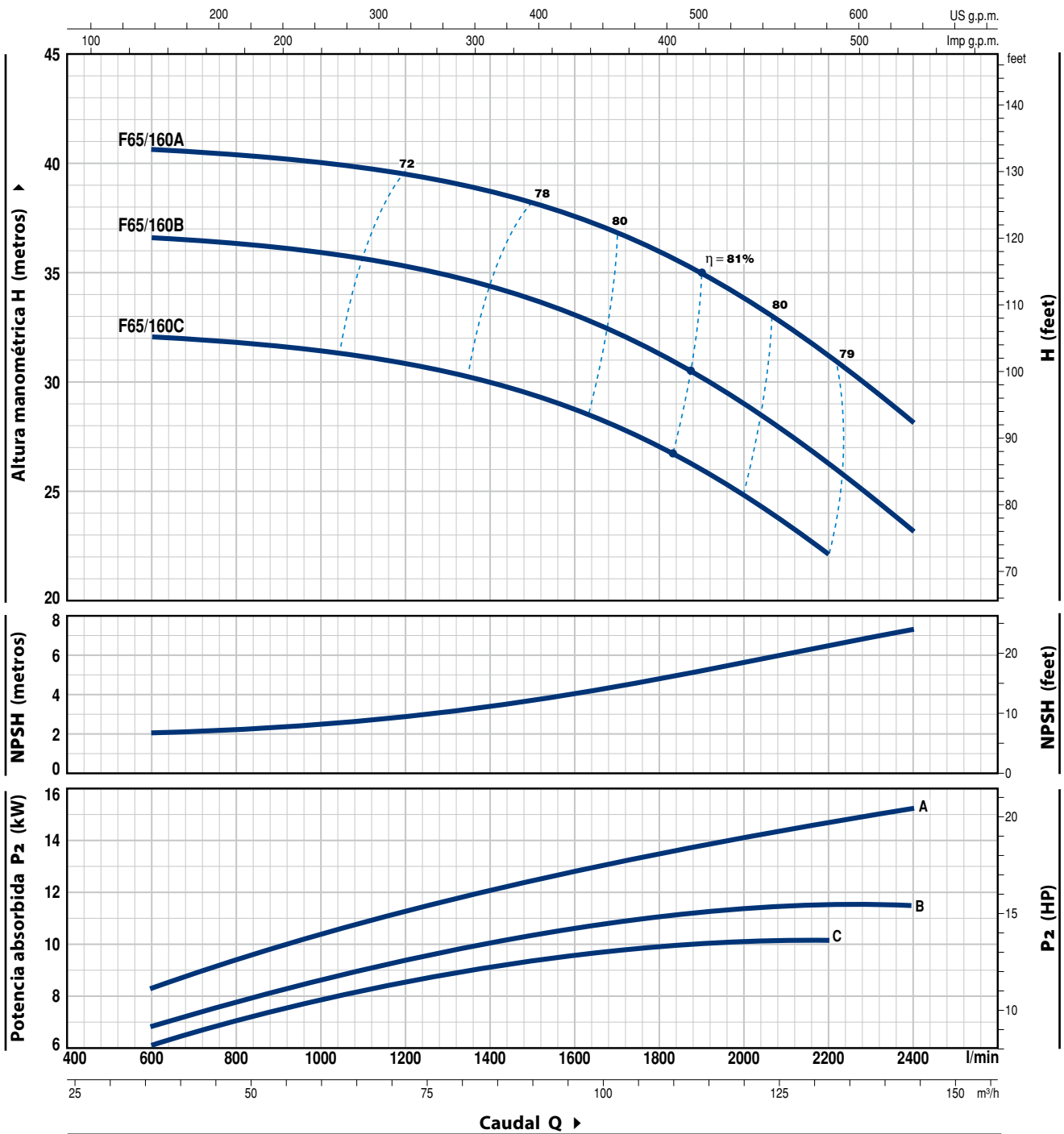

MODELO	POTENCIA (P ₂)		Q	Flow Rate (Q)													
	kW	HP		0	36	48	60	72	84	96	108	120	132	144			
Trifásica			l/min	0	600	800	1000	1200	1400	1600	1800	2000	2200	2400			
F 65/160C	9.2	12.5	H metros	32	32	32	32	32	30	29	27	25	22				
F 65/160B	11	15		37	36.5	36.5	36	35.5	34	33	31	29	26	23			
F 65/160A	15	20		41	40.5	40.5	40	39.5	39	37.5	36	34	31	28			

Q = Caudal H = Altura manométrica total HS = Altura de aspiración

Tolerancia de las curvas de prestación según EN ISO9906 Grado 3B.

F65/200

CURVAS Y DATOS DE PRESTACIONES

60 Hz n = 3450 min⁻¹ HS = 0 m

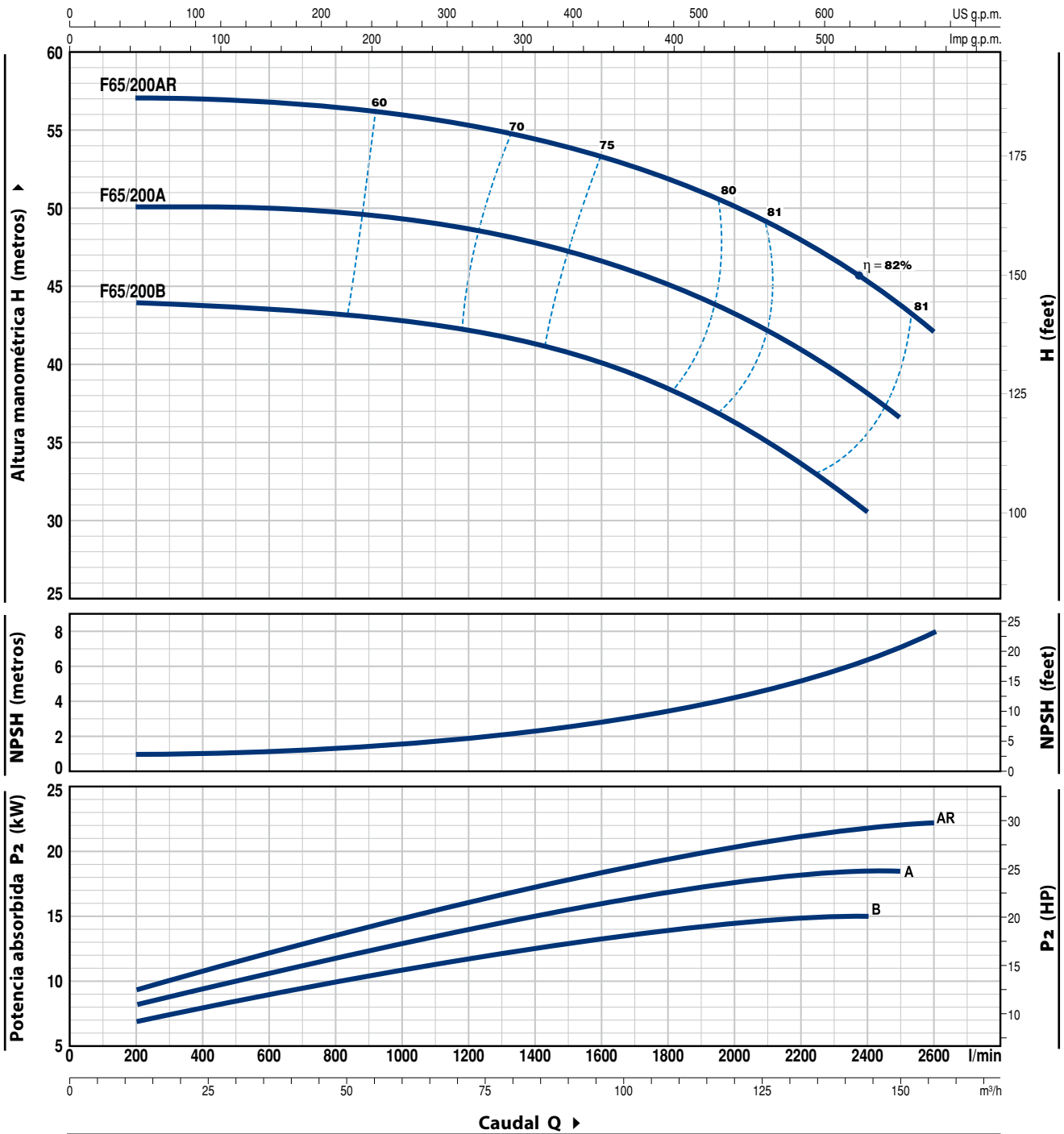

MODELO	POTENCIA (P ₂)		Q	12	36	48	60	72	84	96	108	120	132	144	150	156
	kW	HP		200	600	800	1000	1200	1400	1600	1800	2000	2200	2400	2500	2600
F 65/200B	15	20	H metros	44	43.5	43.3	43	42.5	41.5	40	38.5	36.5	34	30.5		
F 65/200A	18.5	25		50	50	50	49.5	49	48	46.5	45	43	41	38	36.5	
F 65/200AR	22	30		57	57	57	56	55.5	54.5	53.5	52	50	48	45.5	43.5	42

Q = Caudal H = Altura manométrica total HS = Altura de aspiración

Tolerancia de las curvas de prestación según EN ISO9906 Grado 3B.

CURVAS Y DATOS DE PRESTACIONES

60 Hz n = 3450 min⁻¹ HS = 0 m

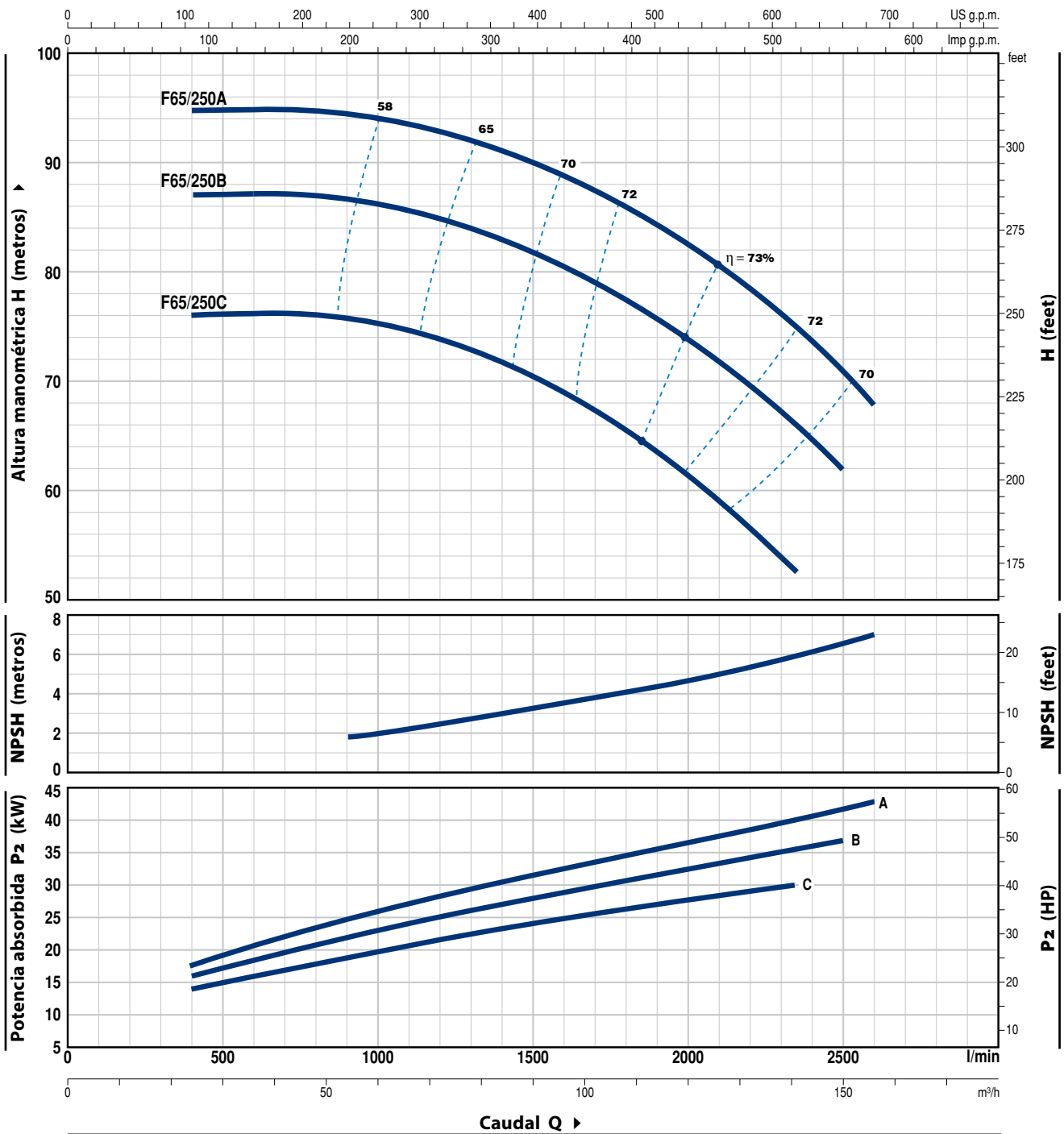

MODELO	POTENCIA (P ₂)		Q	Flow Rate (Q)											
	kW	HP		m ³ /h	24	40	60	80	100	120	141	150	156		
Trifásica			l/min	400	667	1000	1333	1667	2000	2350	2500	2600			
F 65/250C	30	40	H metros	76	76	75.5	72.5	68	61.5	53					
F 65/250B	37	50		87	87	86	84	80	74	66.5	62				
F 65/250A	45	60		95	95	94	92	88	82.5	75	71	68			

Q = Caudal H = Altura manométrica total HS = Altura de aspiración

Tolerancia de las curvas de prestación según EN ISO9906 Grado 3B.

F80/160

CURVAS Y DATOS DE PRESTACIONES

60 Hz n = 3450 min⁻¹ HS = 0 m

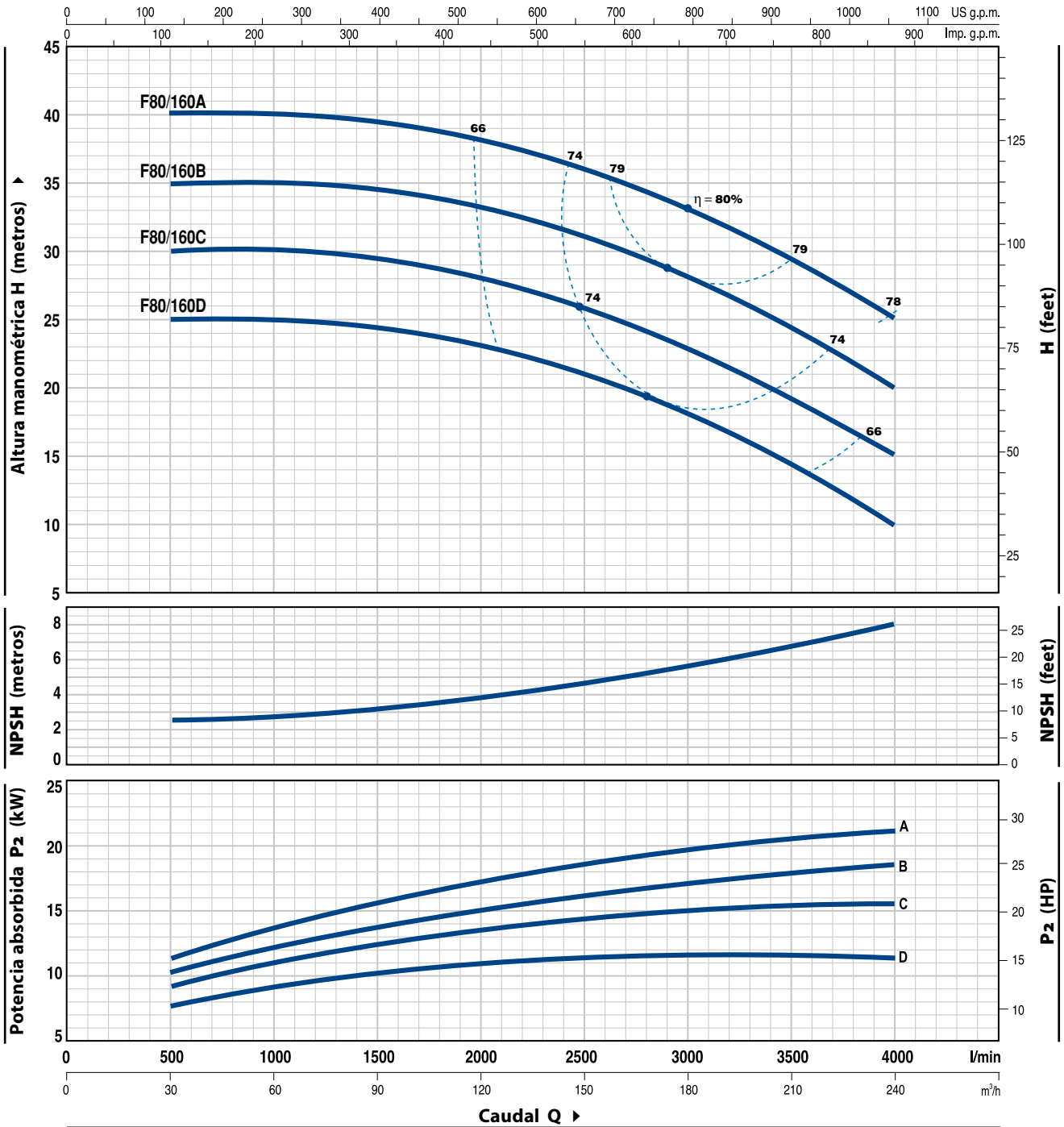

MODELO	POTENCIA (P ₂)		Q	H metros											
	kW	HP		0	30	60	90	120	150	180	210	240			
Trifásica			l/min	0	500	1000	1500	2000	2500	3000	3500	4000			
F 80/160D	11	15		25	25	25	24.5	23.5	21	18	14.5	10			
F 80/160C	15	20		30	30	30	29.5	28.5	26	23	19.5	15			
F 80/160B	18.5	25		35	35	35	34.5	33.5	31	28.5	24.5	20			
F 80/160A	22	30		40	40	40	39.5	38.5	36	33	29.5	25			

Q = Caudal H = Altura manométrica total HS = Altura de aspiración

Tolerancia de las curvas de prestación según EN ISO9906 Grado 3B.

CURVAS Y DATOS DE PRESTACIONES

60 Hz n = 3450 min⁻¹ HS = 0 m

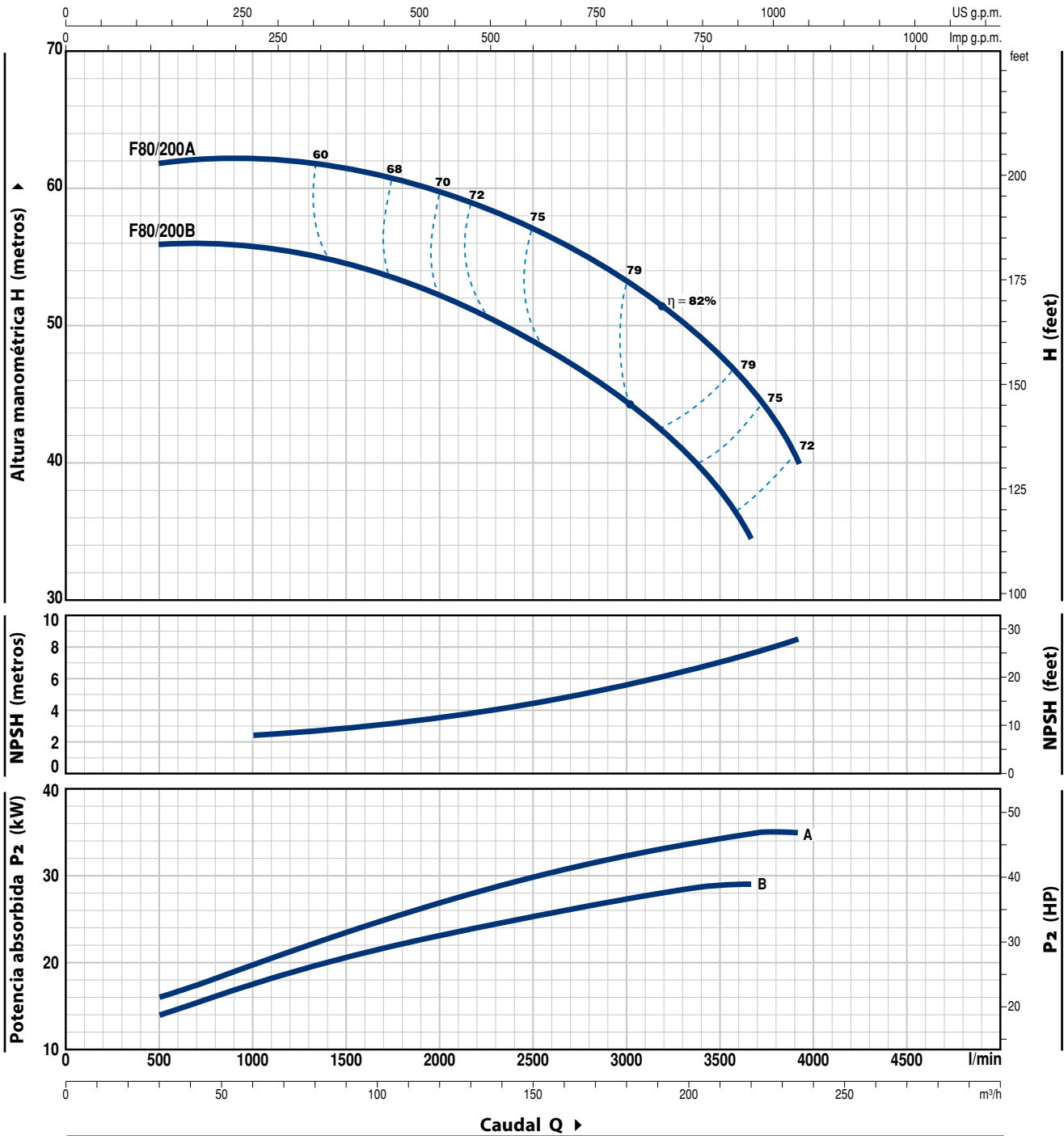

MODELO	POTENCIA (P ₂)		Q	Caudal							
	kW	HP		m ³ /h	30	50	100	150	200	219	234
Trifásica			l/min	500	833	1667	2500	3333	3650	3900	
F 80/200B	30	40	H metros	56	56	54	49	41	34.5		
F 80/200A	37	50		62	62	61	57	50	45.5	40	

Q = Caudal H = Altura manométrica total HS = Altura de aspiración

Tolerancia de las curvas de prestación según EN ISO9906 Grado 3B.

F80/250

CURVAS Y DATOS DE PRESTACIONES

60 Hz n = 3450 min⁻¹ HS = 0 m

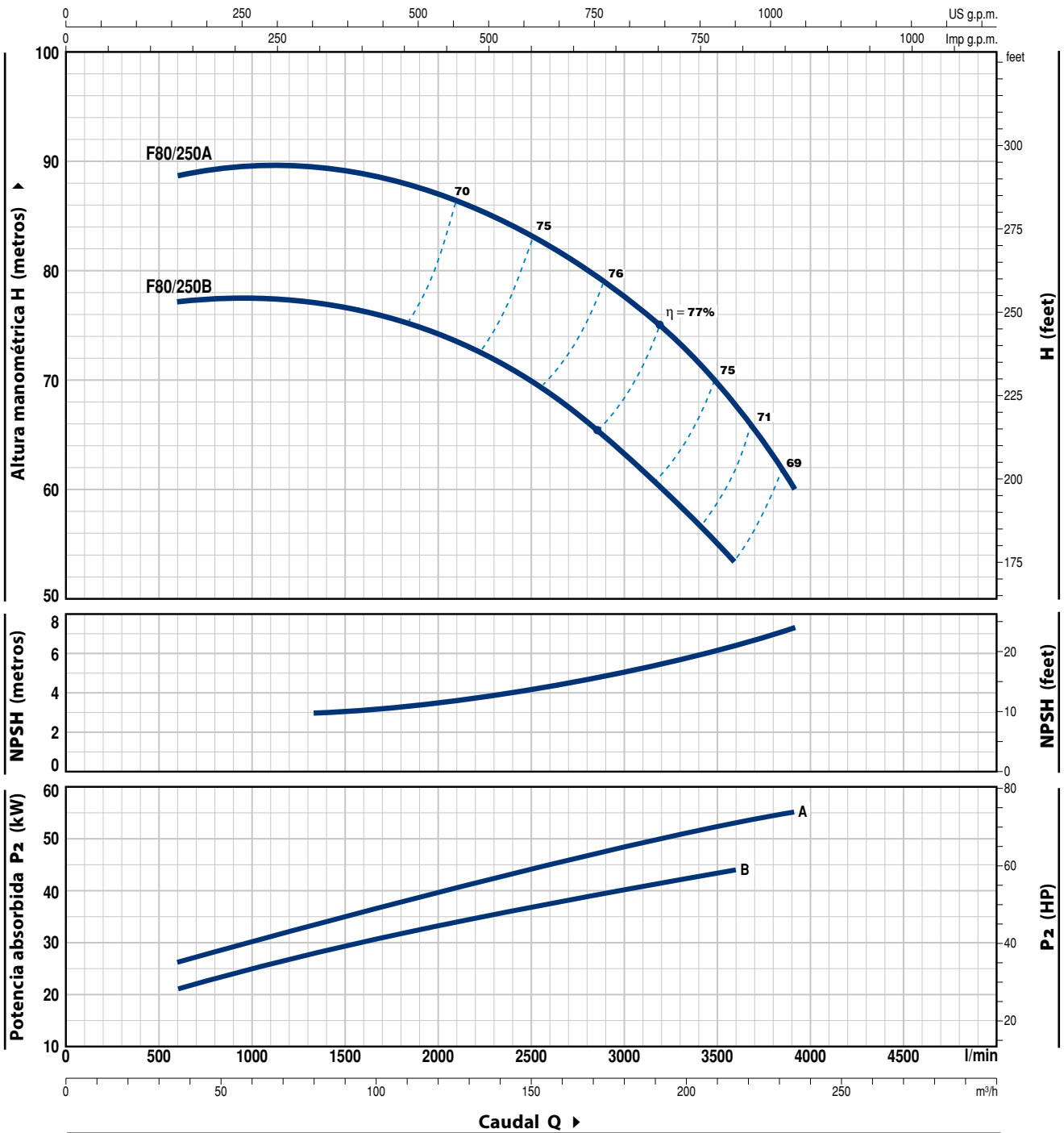

MODELO	POTENCIA (P ₂)		Q	Caudal								
	kW	HP		m ³ /h	l/min	36	50	100	150	200	216	234
Trifásica				600	833	1667	2500	3333	3600	3900		
F 80/250B	45	60	H metros	77	77.5	76	70.5	58.5	54			
F 80/250A	55	75		88.5	89.5	89	83	72	68	60		

Q = Caudal H = Altura manométrica total HS = Altura de aspiración

Tolerancia de las curvas de prestación según EN ISO9906 Grado 3B.

CURVAS Y DATOS DE PRESTACIONES

60 Hz n= 3450 min⁻¹ HS= 0 m

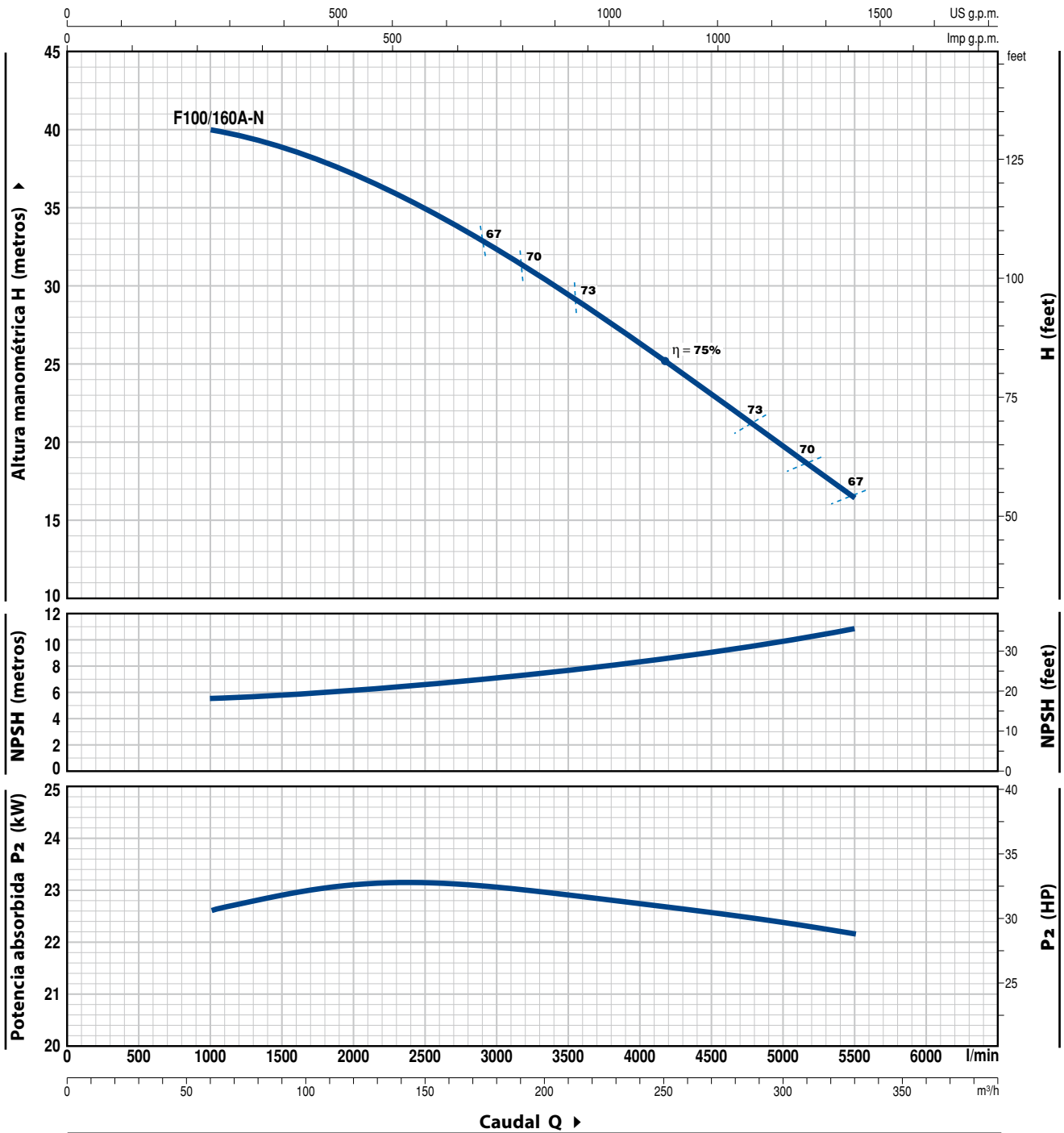

MODELO	POTENCIA (P ₂)		Q	Caudal (l/min)									
	kW	HP		0	60	120	180	240	270	300	330		
Trifásica			m ³ /h	0	60	120	180	240	270	300	330		
			l/min	0	1000	2000	3000	4000	4500	5000	5500		
F 100/160A-N	22	30	H metros	40.5	40	37	32	26	23	19.5	16.5		

Q = Caudal H = Altura manométrica total HS = Altura de aspiración

Tolerancia de las curvas de prestación según EN ISO9906 Grado 3B.

F100/200

CURVAS Y DATOS DE PRESTACIONES

60 Hz n = 3450 min⁻¹ HS = 0 m

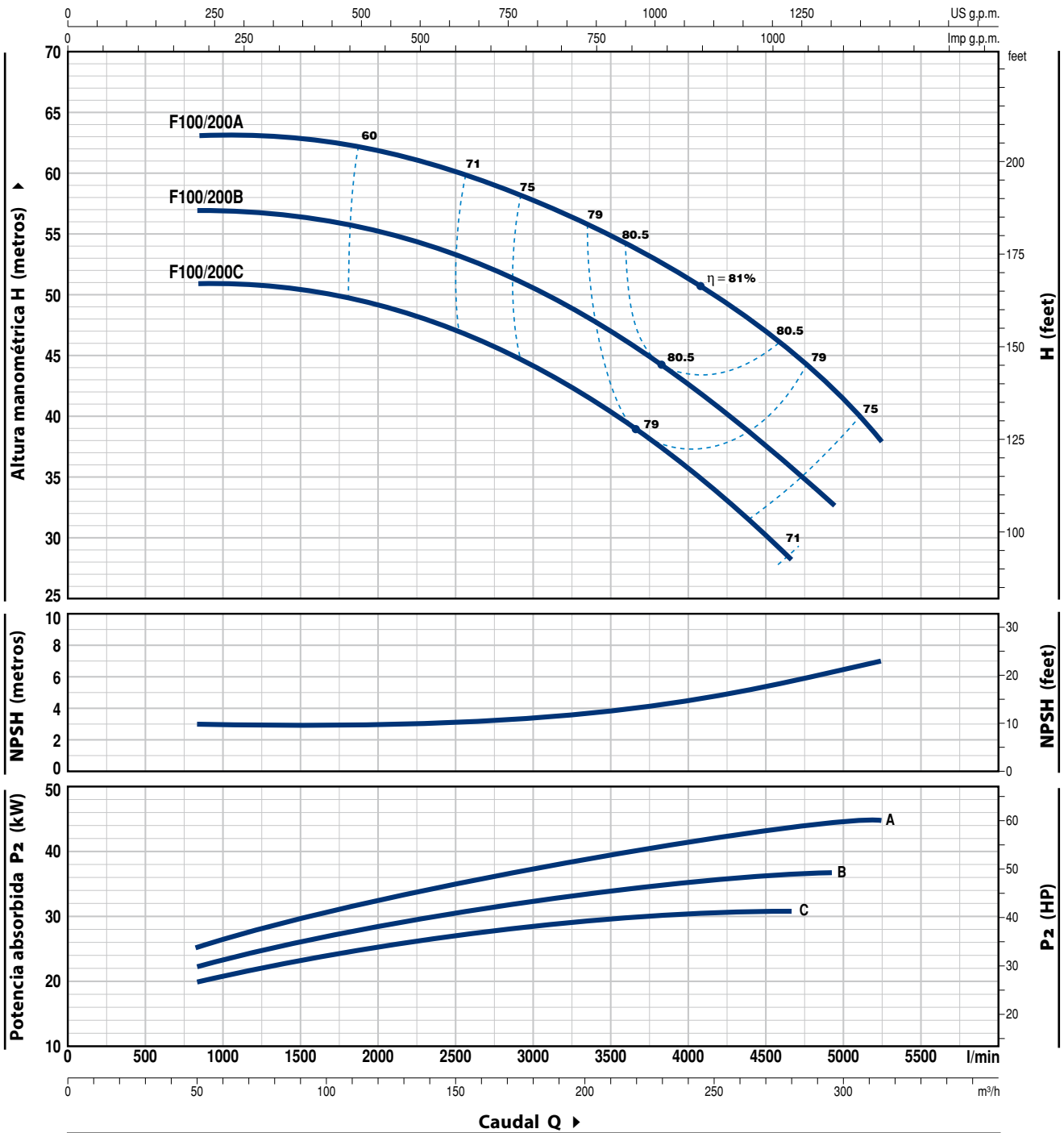

MODELO	POTENCIA (P ₂)		Q	Caudal Q											
	kW	HP		m ³ /h	0	50	100	150	200	250	279	294	300	315	
Trifásica			l/min	0	833	1667	2500	3333	4167	4650	4900	5000	5250		
F 100/200C	30	40	H metros	51	51	50	47	41.5	34	28					
F 100/200B	37	50		57	57	56	53	48	41	36	33				
F 100/200A	45	60		63	63	62.5	60	56	50	45	42.5	41.5	38		

Q = Caudal H = Altura manométrica total HS = Altura de aspiración

Tolerancia de las curvas de prestación según EN ISO9906 Grado 3B.

CURVAS Y DATOS DE PRESTACIONES

60 Hz n = 3450 min⁻¹ HS = 0 m

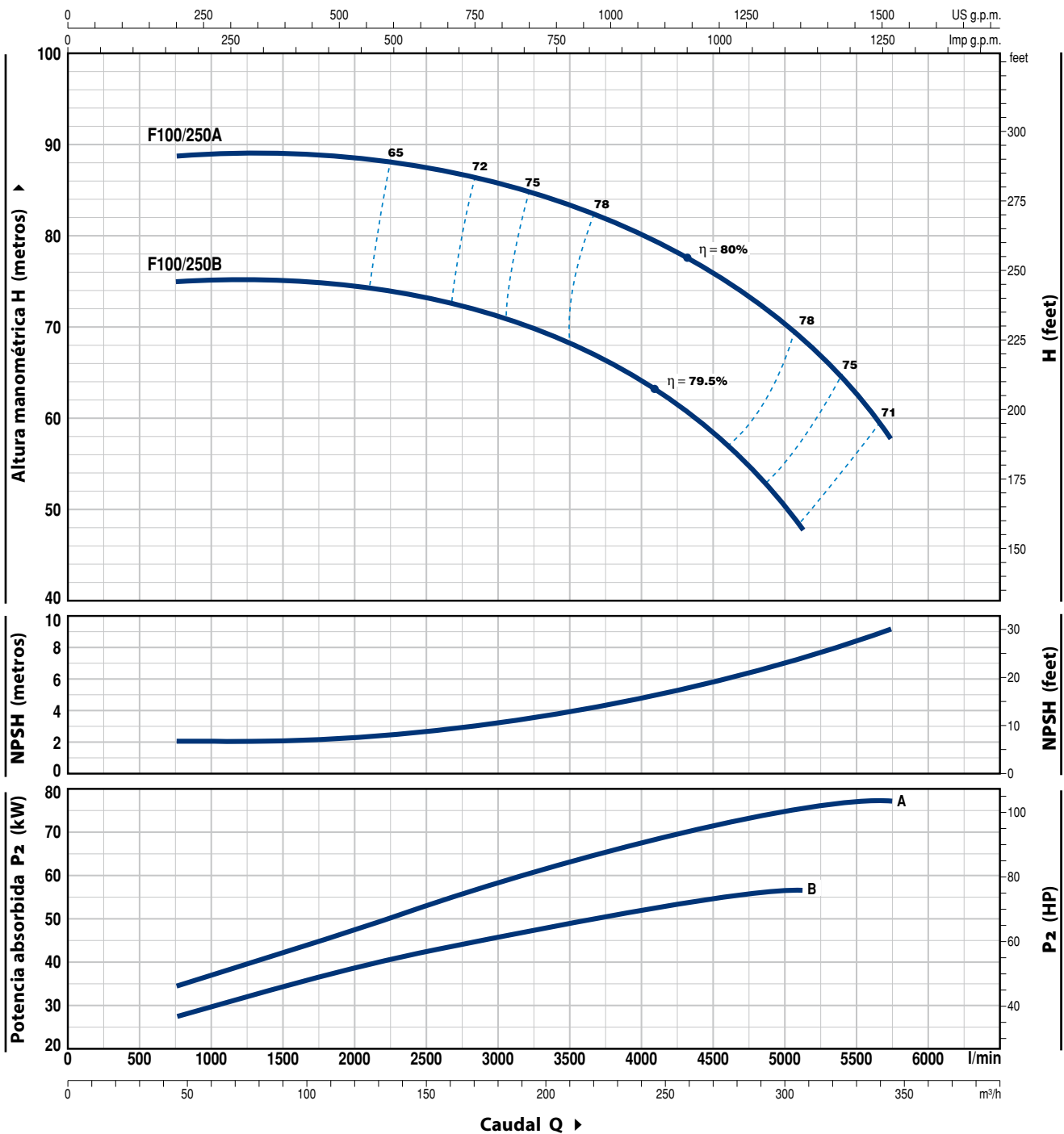

MODELO	POTENCIA (P ₂)		Q	48	96	150	180	210	240	300	309	345
	kW	HP		800	1600	2500	3000	3500	4000	5000	5150	5750
F 100/250B	55	75	H metros	75	75	74	71.5	69	64.5	51	48	
F 100/250A	75	100		89	89	88.5	87	84	80.5	70.5	69	58

Q = Caudal H = Altura manométrica total HS = Altura de aspiración

Tolerancia de las curvas de prestación según EN ISO9906 Grado 3B.

POS. COMPONENTE CARACTERISTICAS CONSTRUCTIVAS

1 CUERPO BOMBA	Hierro fundido con bocas de aspiración e impulsión con bridas				
2a TAPA	Hierro fundido para F32/160, F32/200, F40/125, F40/160, F40/200, F50/125, F50/160, F65/125				
2b SOPORTE	Hierro fundido para F32/250, F40/250, F50/200, F50/250, F65/160, F65/200, F65/250, F80/160, F80/200, F80/250, F100/160, F100/200, F100/250				
3 RODETE	Latón para F32/160, F32/200, F40/125, F40/160, F40/200, F50/125, F50/160 Hierro fundido para F32/250, F40/250, F50/200, F50/250, F65/125, F65/160, F65/200, F65/250, F80/160, F80/200, F80/250, F100/160, F100/200, F100/250				
4 EJE MOTOR	Acero inoxidable AISI 431				
5 SELLO MECANICO	Electrobomba	Sello	Eje	Materiales	
	Modelo	Modelo	Diámetro	Anillo fijo	Anillo móvil Elastómero
	F32/160, F40/125, F40/160, 50/125	FN-20	Ø 20 mm	Grafito	Cerámica NBR
	F32/200, F40/200, F50/160, F65/125	FN-24	Ø 24 mm	Grafito	Cerámica NBR
	F50/200, F65/160, F65/200, F80/160, F100/160	FN-32 NU	Ø 32 mm	Grafito	Cerámica NBR
	F32/250, F40/250, F50/250	FN-38	Ø 38 mm	Grafito	Cerámica NBR
	F65/250, F80/200, F80/250B, F100/200	FN-40 NU	Ø 40 mm	Grafito	Cerámica NBR
	F80/250A, F100/250	FH-45 NU	Ø 45 mm	Grafito	Cerámica NBR
6 RODAMIENTOS	Electrobomba	Modelo	Electrobomba	Modelo	
	F32/160C F40/160C	6206 ZZ-C3 / 6204 ZZ	F32/250 F50/200	6310 ZZ-C3 / 6308 ZZ-C3	
	F32/160B F50/125C		F40/250 F65/160		
	F40/125		F50/250 F80/160		
	Fm32/160B F32/160A	6206 ZZ-C3 / 6205 ZZ	F65/200 F100/160	6312 ZZ-C3 / 6212 ZZ-C3	
	Fm40/160C F40/160B		F65/250 F80/200		
	Fm50/125C F50/125B		F80/250B F100/200		
	F40/160A	6306 ZZ-C3 / 6206 ZZ-C3	F80/250A	6314 ZZ-C3 / 6313 ZZ-C3	
	F50/125A		F100/250		
	F32/200 F40/200	6307 ZZ-C3 / 6206 ZZ-C3			
	F50/160 F65/125				

7 CONDENSADOR	Electrobomba	Capacidad
	Monofásica	(220 V)
	Fm32/160C	45 µF - 450 VL
	Fm32/160B	70 µF - 450 VL
	Fm40/125C	31.5 µF - 450 VL
	Fm40/125B	45 µF - 450 VL
	Fm40/125A	50 µF - 450 VL
	Fm40/160C	70 µF - 450 VL
	Fm50/125C	70 µF - 450 VL

8 MOTOR ELECTRICO **Fm:** monofásica 220 V - 60 Hz con protección térmica incorporada en el bobinado (hasta 1.5 kW)
F: trifásica 220/380 V - 60 Hz o 220/440 V - 60 Hz hasta to 22 kW
 380/660 V - 60 Hz de 30 a 75 kW

► Las electrobombas trifásicas están equipadas con motores de alto rendimiento en clase IE2 hasta P₂=1.1 kW y en clase IE3 desde P₂=1.5 kW (IEC 60034-30)

- Aislamiento: clase F - Protección: IP 55

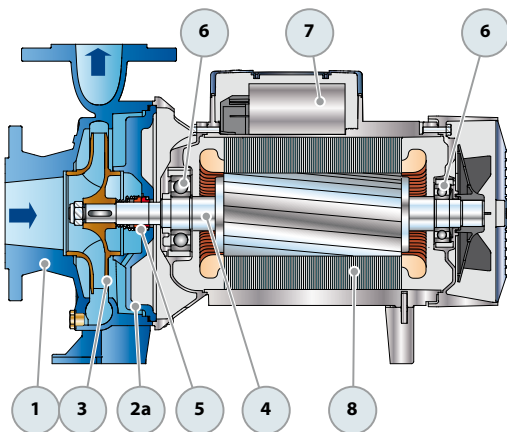

Versión monofásica

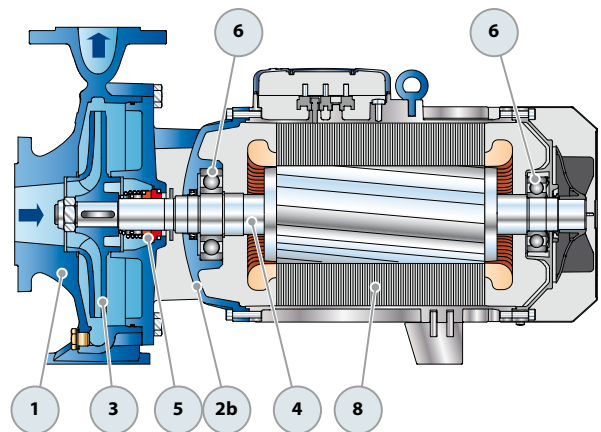

Versión trifásica

CONSUMO EN AMPERIOS

MODEL	TENSION
Single-phase	220 V
Fm 32/160C	11.0 A
Fm 32/160B	15.0 A
Fm 40/125C	8.0 A
Fm 40/125B	11.0 A
Fm 40/125A	14.5 A
Fm 40/160C	17.0 A
Fm 50/125C	17.0 A

MODELO	TENSION				
	220 V	380 V	660 V	220 V	440 V
Trifásica					
F 32/160C	7.8 A	4.5 A	2.6 A	8.0 A	4.5 A
F 32/160B	10.0 A	5.8 A	3.4 A	9.5 A	5.5 A
F 32/160A	12.1 A	7.0 A	4.0 A	12.1 A	6.5 A
F 32/200C	18.9 A	10.9 A	6.3 A	18.5 A	12.3 A
F 32/200B	24.0 A	13.9 A	8.0 A	22.0 A	13.8 A
F 32/200A	27.0 A	15.6 A	9.0 A	27.0 A	18.0 A
F 32/200BH	13.5 A	7.8 A	4.5 A	12.7 A	7.7 A
F 32/200AH	18.0 A	10.4 A	6.0 A	17.5 A	11.0 A
F 32/250C	38.0 A	22.0 A	12.7 A	39.8 A	20.0 A
F 32/250B	43.0 A	25.0 A	14.5 A	36.5 A	21.0 A
F 32/250A	57.0 A	33.0 A	19.1 A	60.0 A	34.0 A
F 40/125C	6.0 A	3.5 A	2.0 A	6.2 A	3.5 A
F 40/125B	7.8 A	4.5 A	2.6 A	8.0 A	4.5 A
F 40/125A	10.0 A	5.8 A	3.4 A	9.5 A	5.5 A
F 40/160C	10.0 A	5.8 A	3.4 A	8.7 A	5.0 A
F 40/160B	12.0 A	6.9 A	4.0 A	12.1 A	6.5 A
F 40/160A	20.9 A	12.1 A	7.0 A	19.5 A	12.5 A
F 40/200B	28.5 A	16.5 A	9.5 A	22.7 A	15.4 A
F 40/200A	30.9 A	17.8 A	10.3 A	28.5 A	21.8 A
F 40/250C	38.0 A	22.0 A	12.7 A	39.8 A	20.0 A
F 40/250B	43.0 A	25.0 A	14.5 A	36.5 A	21.0 A
F 40/250A	57.0 A	33.0 A	19.1 A	60.0 A	34.0 A
F 50/125C	10.7 A	6.2 A	3.6 A	9.8 A	6.7 A
F 50/125B	11.3 A	6.5 A	3.8 A	12.0 A	6.5 A
F 50/125A	18.2 A	10.5 A	6.1 A	19.0 A	12.5 A
F 50/160C	17.7 A	10.3 A	6.0 A	16.4 A	12.5 A
F 50/160B	21.0 A	12.0 A	6.9 A	20.8 A	13.5 A
F 50/160A	28.0 A	16.5 A	9.5 A	26.7 A	17.5 A
F 50/200C	46.0 A	26.5 A	15.3 A	47.0 A	25.0 A
F 50/200B	56.0 A	32.0 A	18.5 A	58.0 A	30.0 A
F 50/200A	67.5 A	39.0 A	22.5 A	70.0 A	36.0 A
F 50/200AR	87.0 A	51.0 A	29.5 A	78.0 A	45.0 A

MODELO	TENSION				
	220 V	380 V	660 V	220 V	440 V
Trifásica					
F 50/250D	32.5 A	18.5 A	10.7 A	29.5 A	17.0 A
F 50/250C	44.0 A	25.0 A	14.5 A	36.5 A	21.0 A
F 50/250B	52.0 A	30.0 A	17.3 A	50.0 A	26.0 A
F 50/250A	64.0 A	37.0 A	21.4 A	66.0 A	36.0 A
F 50/250AR	82.0 A	48.0 A	27.7 A	83.0 A	47.0 A
F 65/125C	18.0 A	10.4 A	6.0 A	19.5 A	12.5 A
F 65/125B	22.5 A	13.0 A	7.5 A	22.0 A	13.8 A
F 65/125A	28.8 A	16.6 A	9.6 A	32.0 A	19.5 A
F 65/160C	37.0 A	21.5 A	12.4 A	37.0 A	24.0 A
F 65/160B	47.0 A	27.0 A	15.6 A	48.0 A	26.0 A
F 65/160A	55.0 A	32.0 A	18.5 A	59.0 A	33.0 A
F 65/200B	56.2 A	32.5 A	18.8 A	58.5 A	32.0 A
F 65/200A	73.5 A	42.5 A	24.5 A	70.0 A	36.0 A
F 65/200AR	97.0 A	56.0 A	32.3 A	79.0 A	48.0 A
F 65/250C	-	64.0 A	37.0 A	-	-
F 65/250B	-	70.0 A	40.4 A	-	-
F 65/250A	-	88.0 A	50.8 A	-	-
F 80/160D	45.0 A	26.0 A	15.0 A	50.0 A	27.0 A
F 80/160C	59.0 A	34.0 A	19.7 A	60.0 A	30.0 A
F 80/160B	66.0 A	38.0 A	22.0 A	70.0 A	36.0 A
F 80/160A	93.5 A	54.0 A	31.2 A	79.0 A	48.0 A
F 80/200B	-	61.0 A	35.0 A	-	-
F 80/200A	-	70.0 A	40.5 A	-	-
F 80/250B	-	88.0 A	51.0 A	-	-
F 80/250A	-	112.0 A	65.0 A	-	-
F 100/160A-N	81.5 A	47.0 A	27.2 A	76.0 A	43.0 A
F 100/200C	-	64.0 A	37.0 A	-	-
F 100/200B	-	70.0 A	40.4 A	-	-
F 100/200A	-	88.0 A	50.8 A	-	-
F 100/250B	-	94.0 A	54.3 A	-	-
F 100/250A	-	132.0 A	76.2 A	-	-

DIMENSIONES Y PESOS

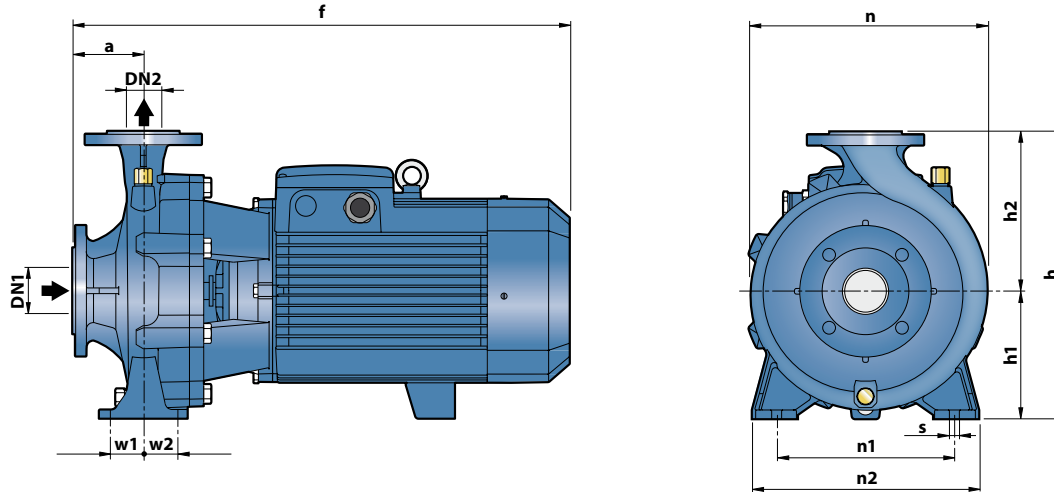

MODELO		DIMENSIONES mm													kg													
Monofásica	Trifásica	DN1	DN2	a	f	h	h1	h2	n	n1	n2	w1	w2	s	1~	3~												
Fm 32/160C	F 32/160C	50	32	80	412	340	160	180	270	190	240	35	35	14	32.7	32.1												
Fm 32/160B	F 32/160B				448/412										292	132	160	242	37.5	33.4								
-	F 32/160A				448										-	-	-	-	-	-								
-	F 32/200C				469										-	-	-	-	-	-								
-	F 32/200B				515										-	-	-	-	-	-								
-	F 32/200A				469										-	-	-	-	-	-								
-	F 32/200BH				-										-	-	-	-	-	-								
-	F 32/200AH				-										-	-	-	-	-	-								
-	F 32/250C				606										405	180	225	330	250	320	47.5	47.5	-	-	-	-	-	
-	F 32/250B				701										-	-	-	-	-	-	-	-	-	-	-	-	-	-
-	F 32/250A	-	-	-	-	-	-	-	-	-	-	-	-	-	-	-												
Fm 40/125C	F 40/125C	65	40	80	421	340	160	180	275	212	265	35	35	14	31.5	29.5												
Fm 40/125B	F 40/125B				451/421										252	112	140	244	160	210	33.0	31.5						
Fm 40/125A	F 40/125A				448/412										-	-	-	-	-	-	-	-	-	-	-	-	-	
Fm 40/160C	F 40/160C				448										292	132	160	240	190	240	35	35	-	-	-	-	-	
-	F 40/160B				465										-	-	-	-	-	-	-	-	-	-	-	-	-	
-	F 40/160A				535										-	-	-	-	-	-	-	-	-	-	-	-	-	
-	F 40/200B				606										405	180	225	328	250	320	47.5	47.5	-	-	-	-	-	
-	F 40/200A				701										-	-	-	-	-	-	-	-	-	-	-	-	-	-
-	F 40/250C				465/431										292	132	160	242	190	240	-	-	-	-	-	-	-	
-	F 40/250B				465										-	-	-	-	-	-	-	-	-	-	-	-	-	-
-	F 40/250A	489	-	-	-	-	-	-	-	-	-	-	-	-	-	-												
Fm 50/125C	F 50/125C	65	50	100	535	360	160	180	269	212	265	35	35	14	37.3	33.2												
-	F 50/125B				616										340	180	269	212	265	-	-	-	-	-	-	-		
-	F 50/125A				711										360	200	316	-	-	-	-	-	-	-	-	-	-	
-	F 50/160C				733										-	-	-	-	-	-	-	-	-	-	-	-	-	
-	F 50/160B				606										405	180	225	337	250	320	47.5	47.5	-	-	-	-	-	
-	F 50/160A				701										-	-	-	-	-	-	-	-	-	-	-	-	-	
-	F 50/200C				711										360	200	316	-	-	-	-	-	-	-	-	-	-	
-	F 50/200B				733										-	-	-	-	-	-	-	-	-	-	-	-	-	
-	F 50/200A				606										405	180	225	337	250	320	47.5	47.5	-	-	-	-	-	
-	F 50/200AR				701										-	-	-	-	-	-	-	-	-	-	-	-	-	
-	F 50/250D	733	-	-	-	-	-	-	-	-	-	-	-	-	-													
-	F 50/250C	733	-	-	-	-	-	-	-	-	-	-	-	-	-													
-	F 50/250B	701	405	180	225	337	250	320	47.5	47.5	-	-	-	-	-													
-	F 50/250A	733	-	-	-	-	-	-	-	-	-	-	-	-	-													
-	F 50/250AR	733	-	-	-	-	-	-	-	-	-	-	-	-	-													
-	F 65/125C	511	65	80	125	340	160	180	291	212	280	47.5	47.5	14	-	-												
-	F 65/125B	557													340	180	291	212	280	47.5	47.5	-	-					
-	F 65/125A	621													360	200	300	212	280	47.5	47.5	-	-					
-	F 65/160C	716													-	-	-	-	-	-	-	-	-	-	-	-	-	
-	F 65/160B	719													-	-	-	-	-	-	-	-	-	-	-	-	-	
-	F 65/160A	751													-	-	-	-	-	-	-	-	-	-	-	-	-	
-	F 65/200B	751													-	-	-	-	-	-	-	-	-	-	-	-	-	
-	F 65/200A	751													-	-	-	-	-	-	-	-	-	-	-	-	-	
-	F 65/200AR	751													-	-	-	-	-	-	-	-	-	-	-	-	-	
-	F 80/160D	652													405	180	225	250	320	-	-	-	-	-	-	-	-	
-	F 80/160C	747	-	-	-	330	-	-	-	-	-	-	-	-	-													
-	F 80/160B	779	-	-	-	-	-	-	-	-	-	-	-	-	-													
-	F 80/160A	790	-	-	-	-	-	-	-	-	-	-	-	-	-													
-	F 100/160A-N	125	100	125	790	480	200	280	362	280	360	60	60	18	-	151.3												

DIMENSIONES Y PESOS

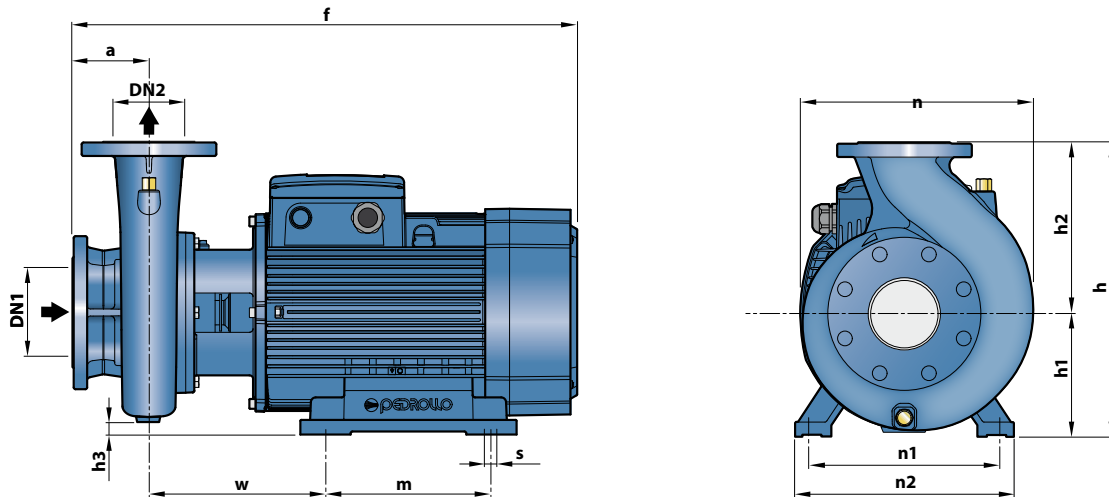

MODELO	DIMENSIONES mm														kg
Trifásica	DN1	DN2	a	f	h	h1	h2	h3	n	n1	n2	w	m	s	3~
F 65/250C	80	65	100	796	450	200	250	15	369	318	360	269.5	305	18.5	201.3
F 65/250B				847											201.3
F 65/250A				847											219.3
F 80/200B	100	80	125	824	430	280	280	25	360	400	490	294	350	24	201.6
F 80/200A				875											201.6
F 80/250B				872											234.5
F 80/250A	125	100	140	1015	620	250	280	55	490	400	490	300	350	24	539.0
F 100/200C				824											225.3
F 100/200B				875											225.3
F 100/200A	125	100	140	875	480	200	280	0	391	318	360	269.5	305	18.5	233.3
F 100/250B				539.3											
F 100/250A				875											539.3

BRIDAS DE LAS BOCAS

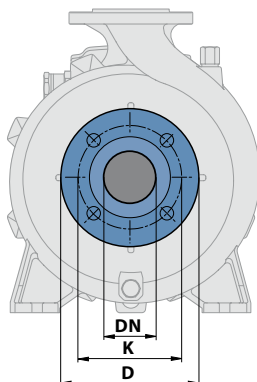

CONTOBRIDAS

(SE PUEDE PEDIR A PARTE)

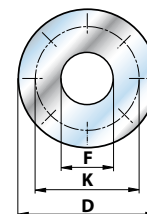

DN BRIDAS mm	D mm	K mm	ORIFICIOS	
			Nº	Ø (mm)
32	140	100	4	18
40	150	110		
50	165	125		
65	185	145		
80	200	160		
100	220	180	8	
125	250	210		

DN BRIDAS mm	F CONTOBRIDAS	D mm	K mm	ORIFICIOS	
				Nº	Ø (mm)
32	1¼"	140	100	4	18
40	1½"	150	110		
50	2"	165	125		
65	2½"	185	145		
80	3"	200	160		
100	4"	220	180	8	
125	5"	250	210		